

Data Driven Agility  
 USDAA Trial  
 Judge Kelly Ely  
 May 10, 2026

## Starters P1 Snooker

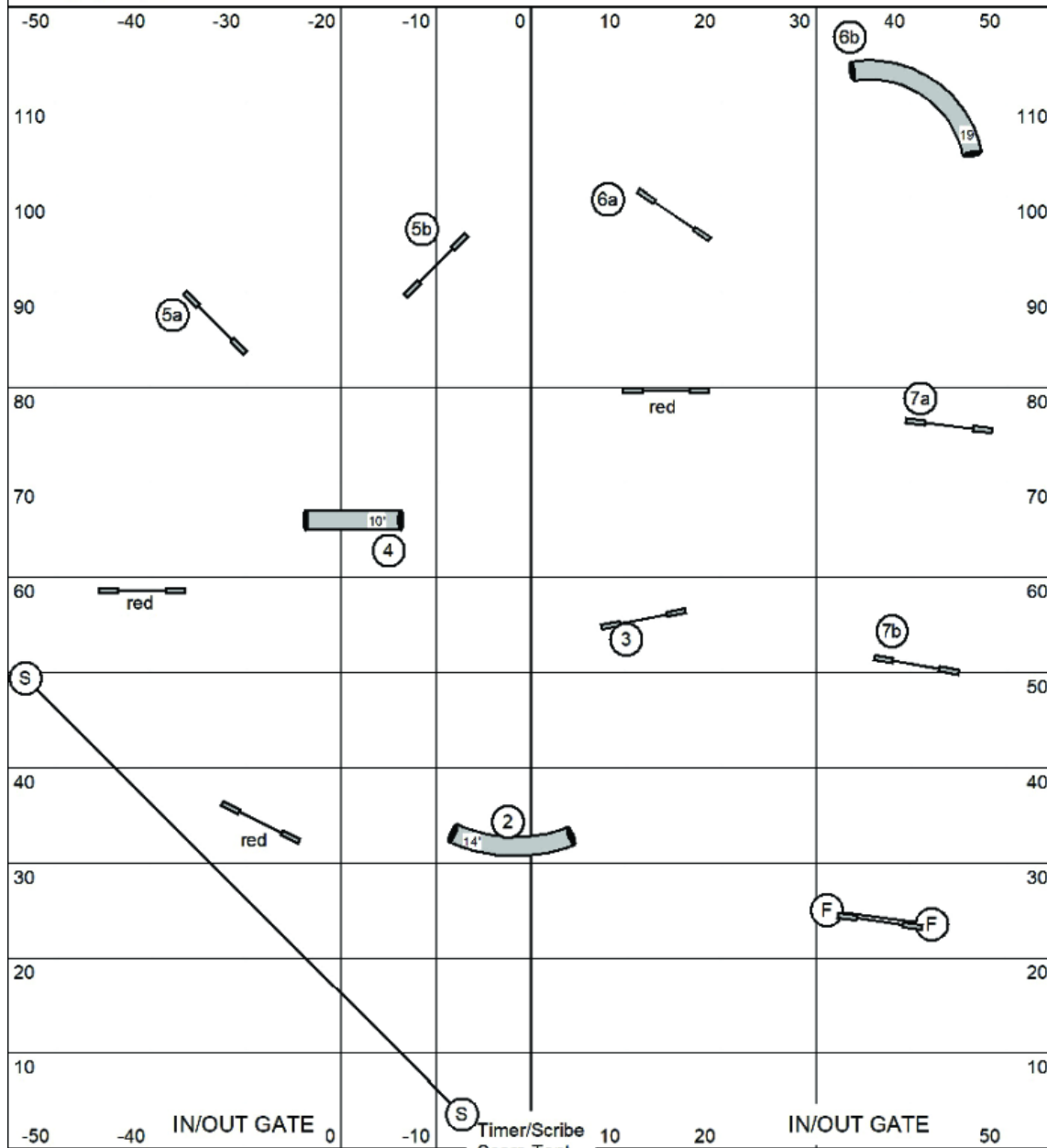

**Opening:**  
 3 reds may be attempted  
 Combo may be taken in any direction.  
 If you fault a combo you must complete it for zero points and to continue.

**Closing:**  
 2 is Bidirectional  
 complete all combos as numbered

**Times:**  
 C24/20 52 sec  
 C16/12 53 sec  
 C 8 54 sec  
 P20/16 53 sec  
 P 12/8 54 sec  
 P4 55 sec

Keep in mind  
 Scoring only ceases when snooker sequence is broken  
 time expires  
 a refusal fault occurs in the closing

Dropped bars are now a 0 but play continues in the opening and closing rounds

Data Driven Agility  
 USDAA Trial  
 Judge Kelly Ely  
 May 10, 2026

### Advanced P2 Snooker

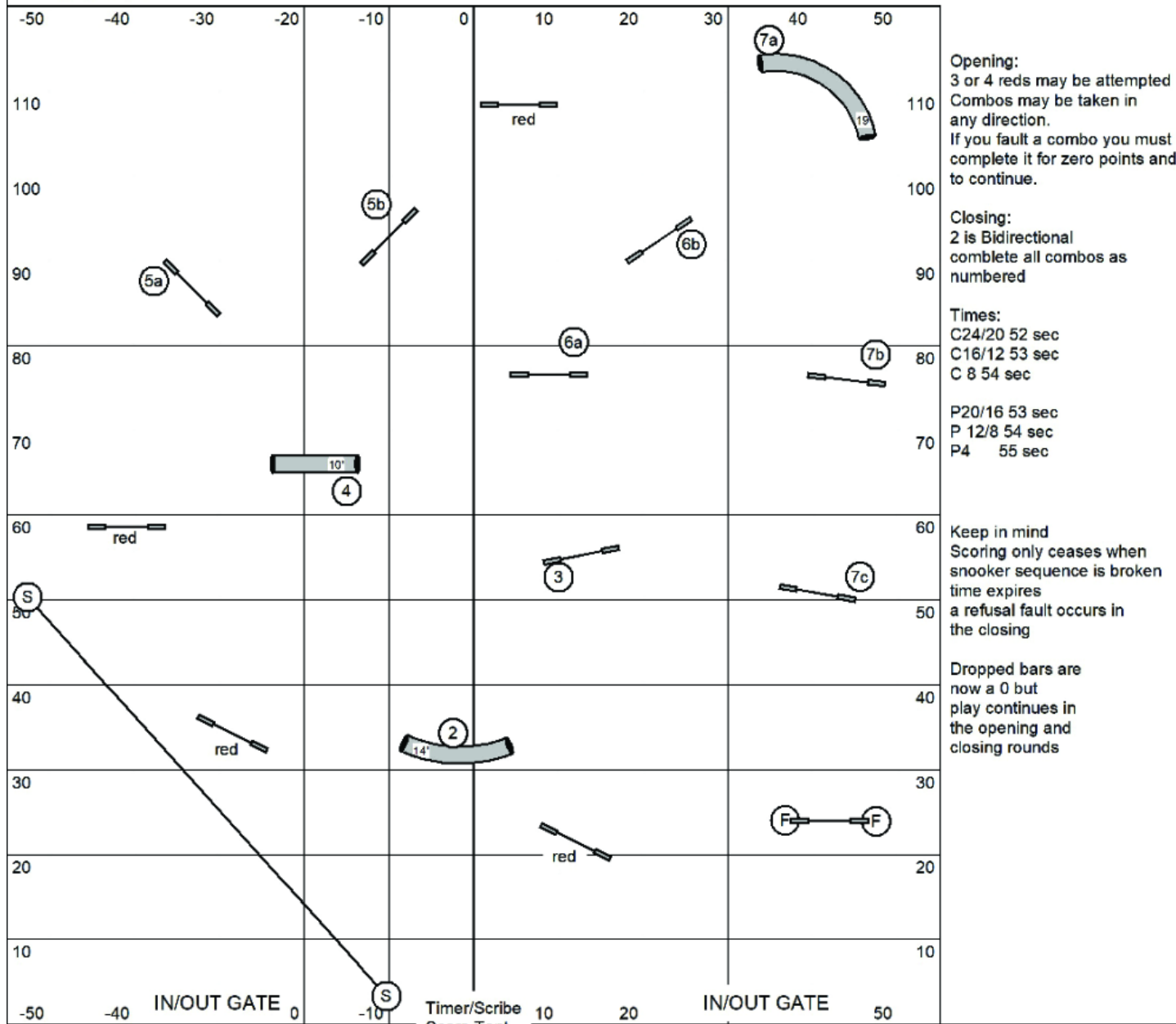

**Opening:**  
 3 or 4 reds may be attempted  
 Combos may be taken in any direction.  
 If you fault a combo you must complete it for zero points and to continue.

**Closing:**  
 2 is Bidirectional  
 complete all combos as numbered

**Times:**  
 C24/20 52 sec  
 C16/12 53 sec  
 C 8 54 sec  
 P20/16 53 sec  
 P 12/8 54 sec  
 P4 55 sec

Keep in mind  
 Scoring only ceases when snooker sequence is broken  
 time expires  
 a refusal fault occurs in the closing

Dropped bars are now a 0 but play continues in the opening and closing rounds

Data Driven Agility  
 USDAA Trial  
 Judge Kelly Ely  
 May 10, 2026

### Masters P3 Vet Snooker

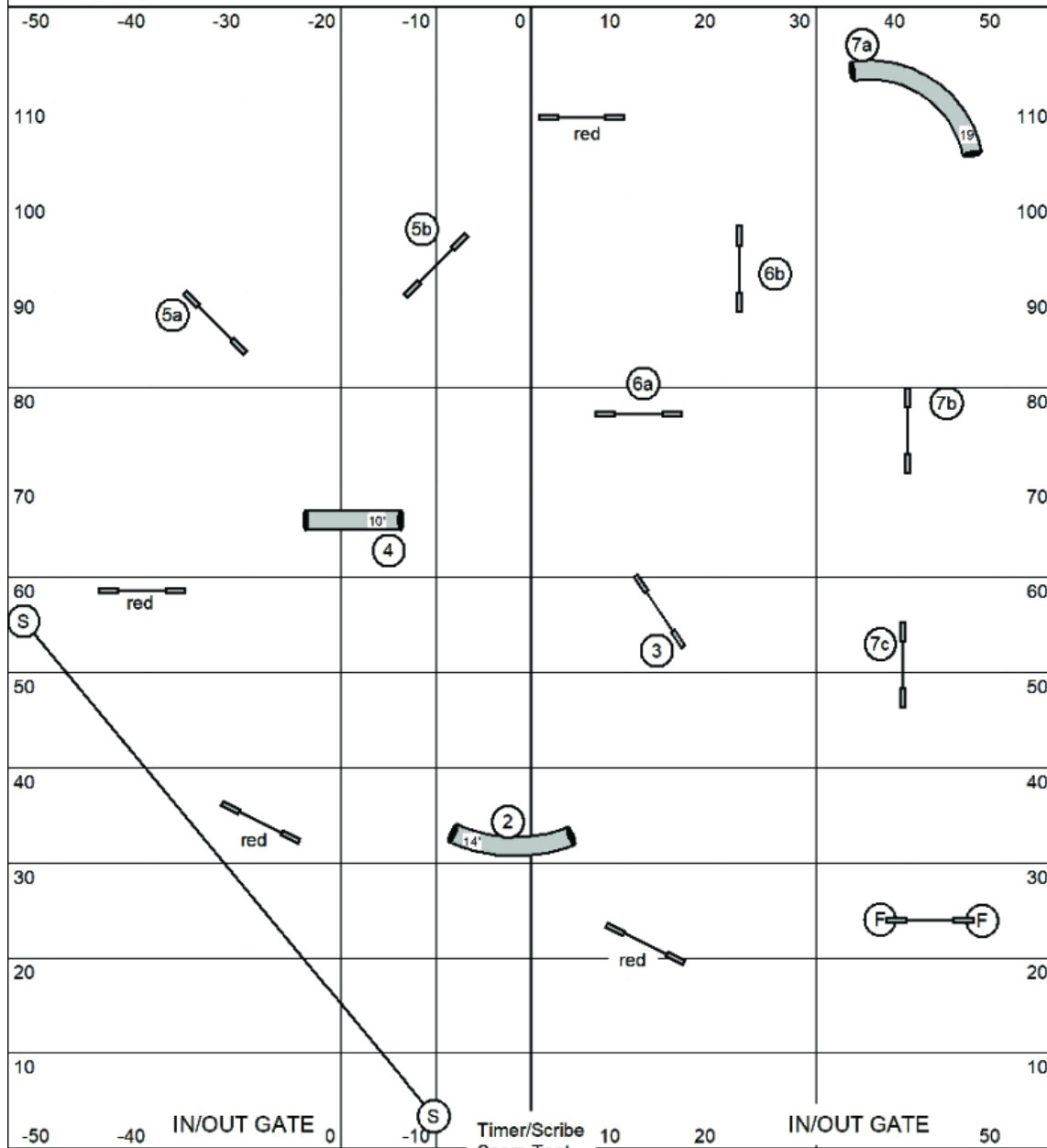

Opening:  
 3 or 4 reds may be attempted  
 Combos may be taken in  
 any direction.  
 If you fault a combo you must  
 complete it for zero points and  
 to continue.

Closing:  
 2 is Bidirectional  
 complete all combos as  
 numbered

Times:  
 C24/20 52 sec  
 C16/12 53 sec  
 C 8 54 sec

P20/16 53 sec  
 P 12/8 54 sec  
 P4 55 sec  
 Vet +6

Refusals in closing  
 except for B or C of  
 a combo

Keep in mind  
 Scoring only ceases when  
 snooker sequence is broken  
 time expires  
 a refusal fault occurs in  
 the closing

Dropped bars are  
 now a 0 but  
 play continues in  
 the opening and  
 closing rounds

Timer/Scribe  
 Score Tent

Data Driven Agility  
 USDAA Trial  
 Judge Kelly Ely  
 May 10, 2026

# Starters P1 Jumpers

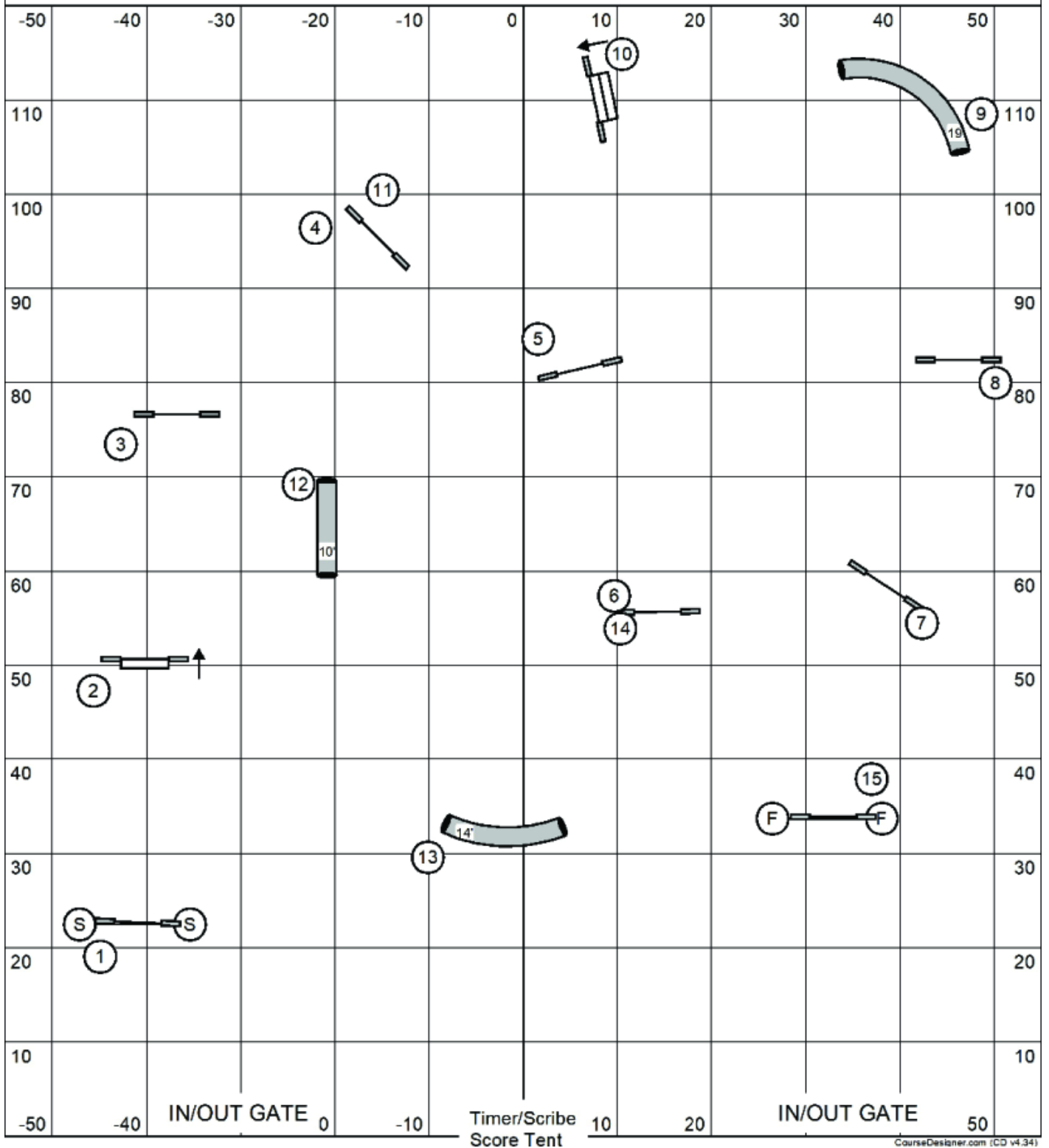

Data Driven Agility  
 USDAA Trial  
 Judge Kelly Ely  
 May 10, 2026

# Advanced P2 Jumpers

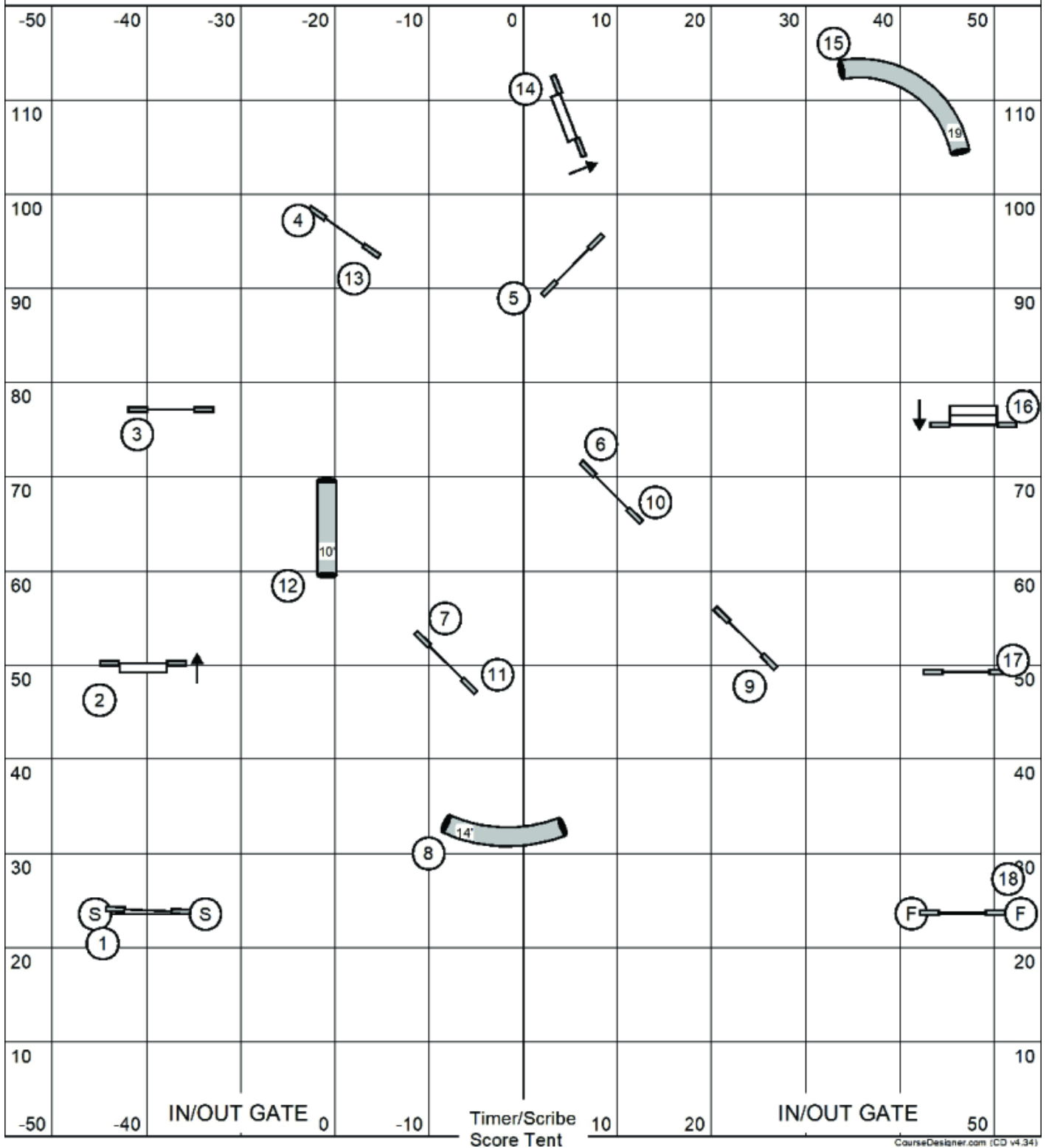

Data Driven Agility  
 USDA Trial  
 Judge Kelly Ely  
 May 10, 2026

# Masters P3 Vet Jumpers

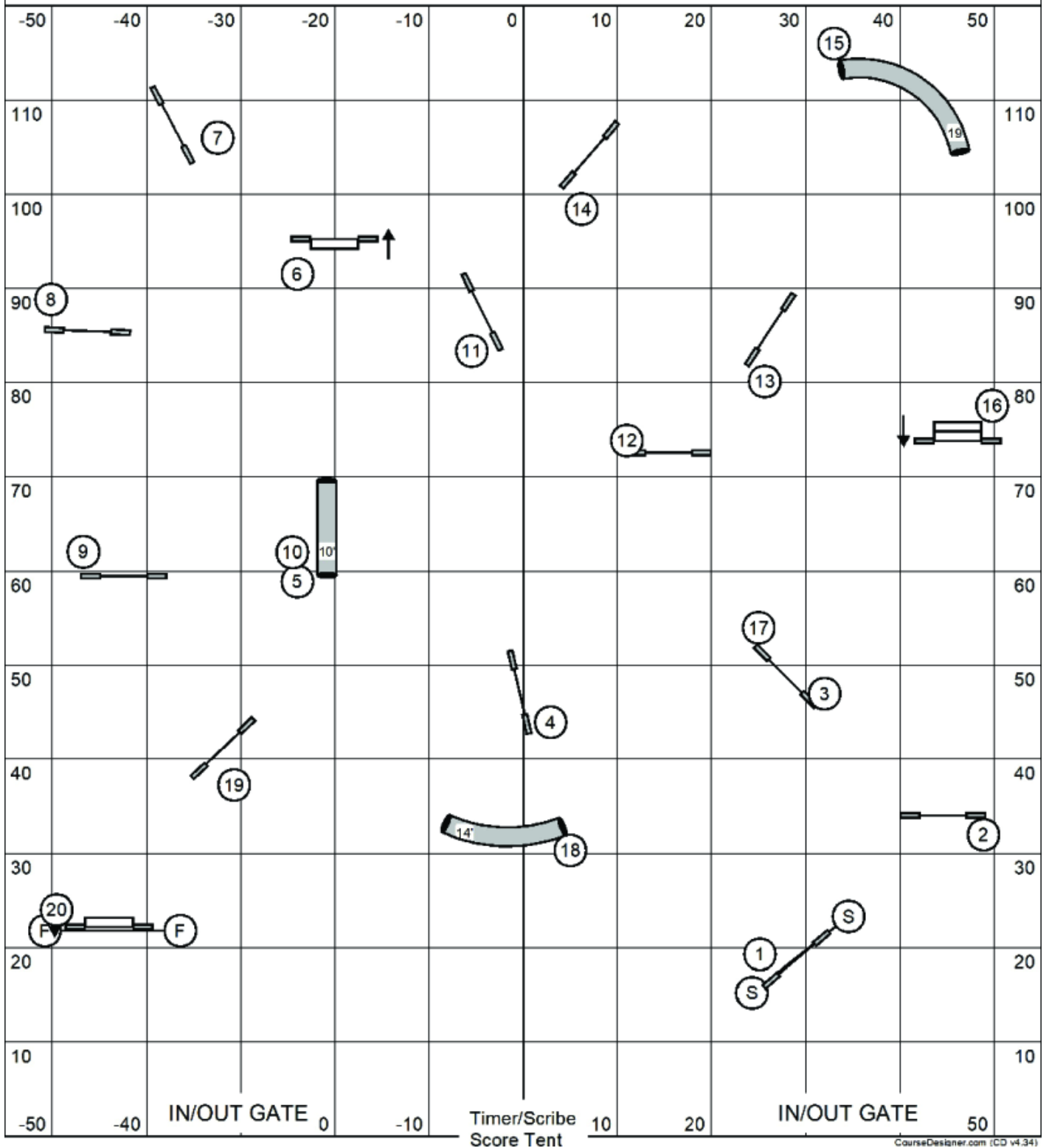



Data Driven Agility  
 USDAA Trial  
 Judge Kelly Ely  
 May 10, 2026

# Purina Pro Plan Steeplechase

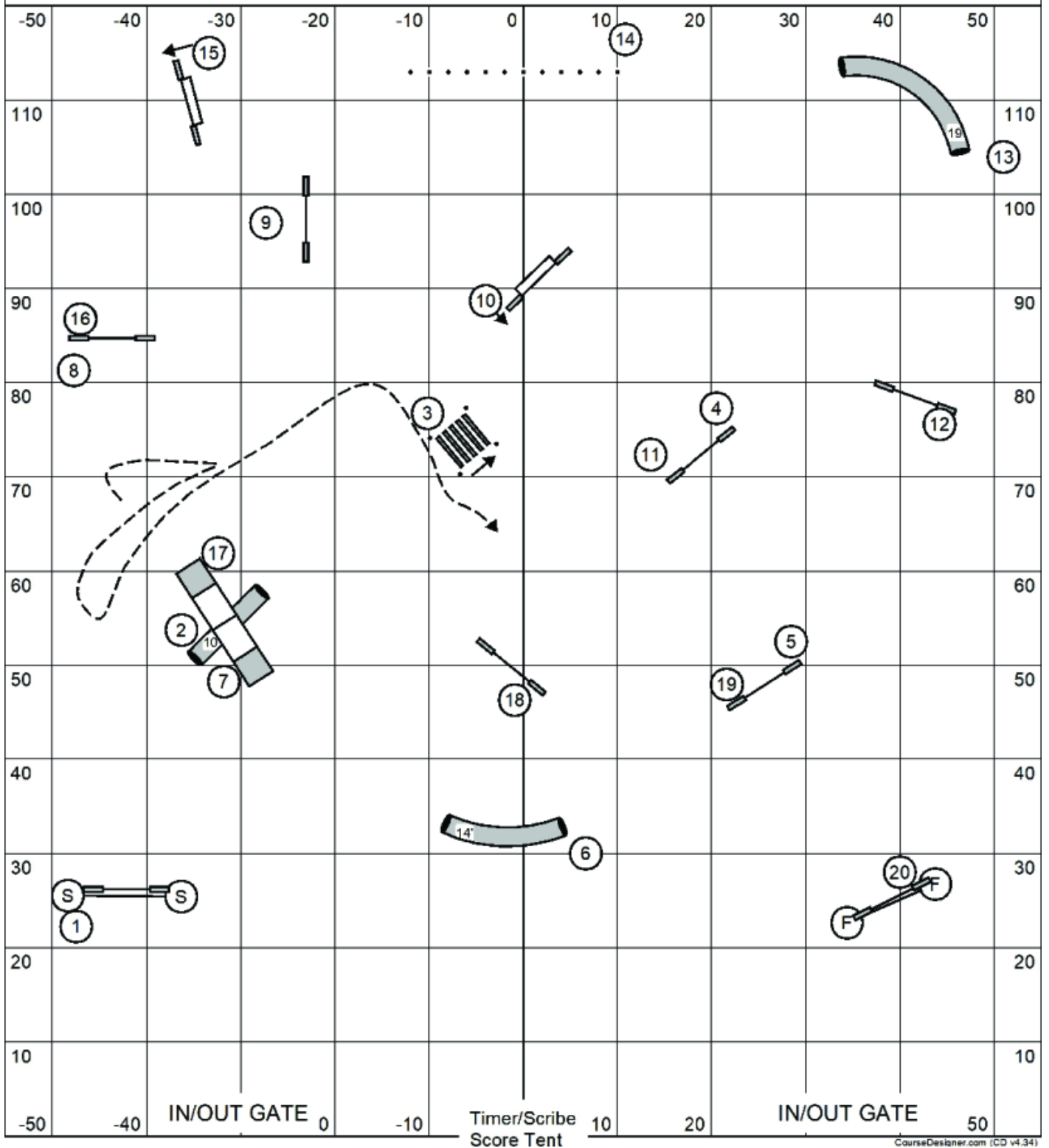

Data Driven Agility  
 USDAA Trial  
 Judge Kelly Ely  
 May 10, 2026

# Starters P1 Standard

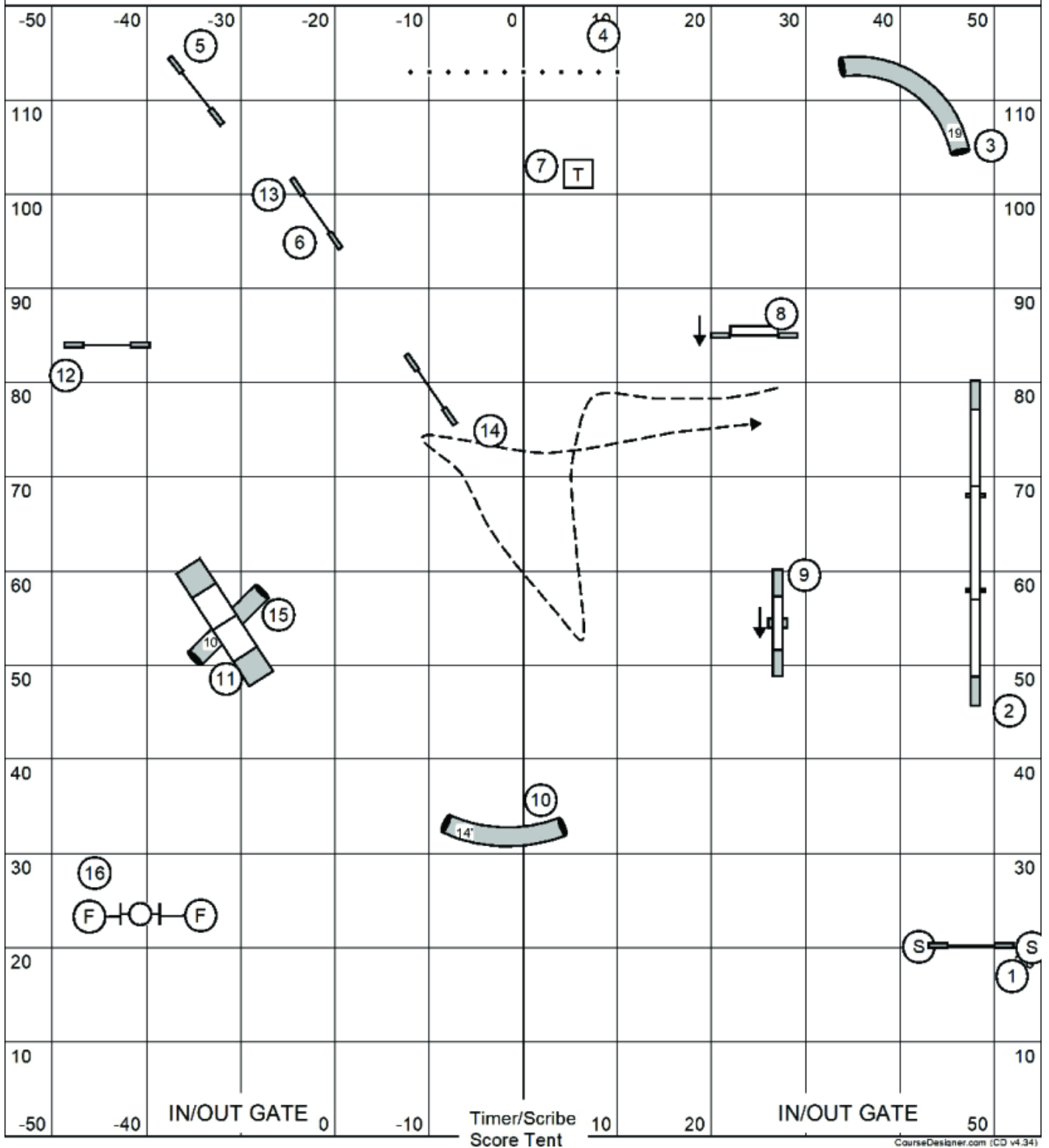

Data Driven Agility  
 USDAA Trial  
 Judge Kelly Ely  
 May 10, 2026

# Advanced P2 Standard

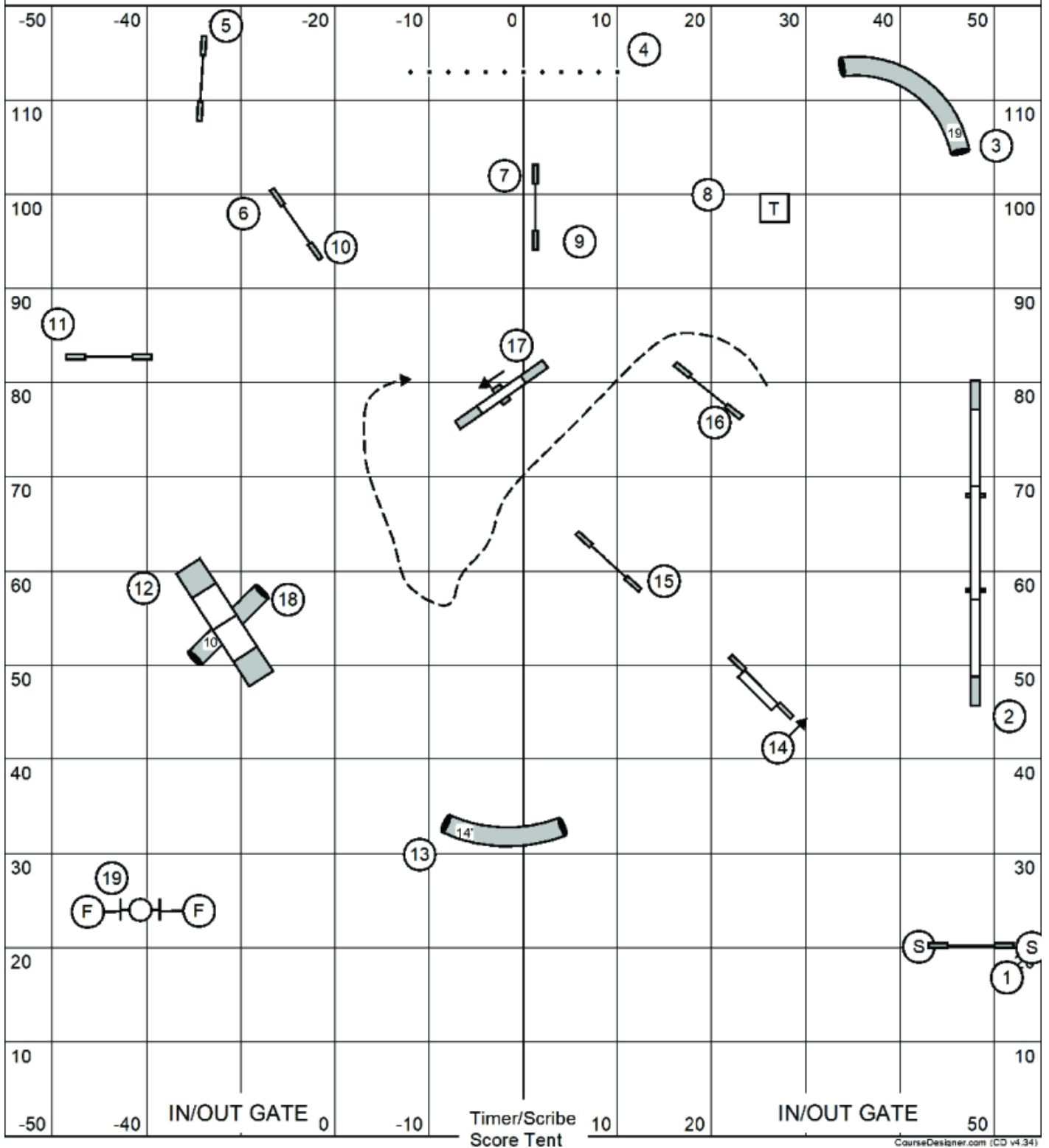

Data Driven Agility  
 USDAA Trial  
 Judge Kelly Ely  
 May 10, 2026

# Masters P3 Vet Standard

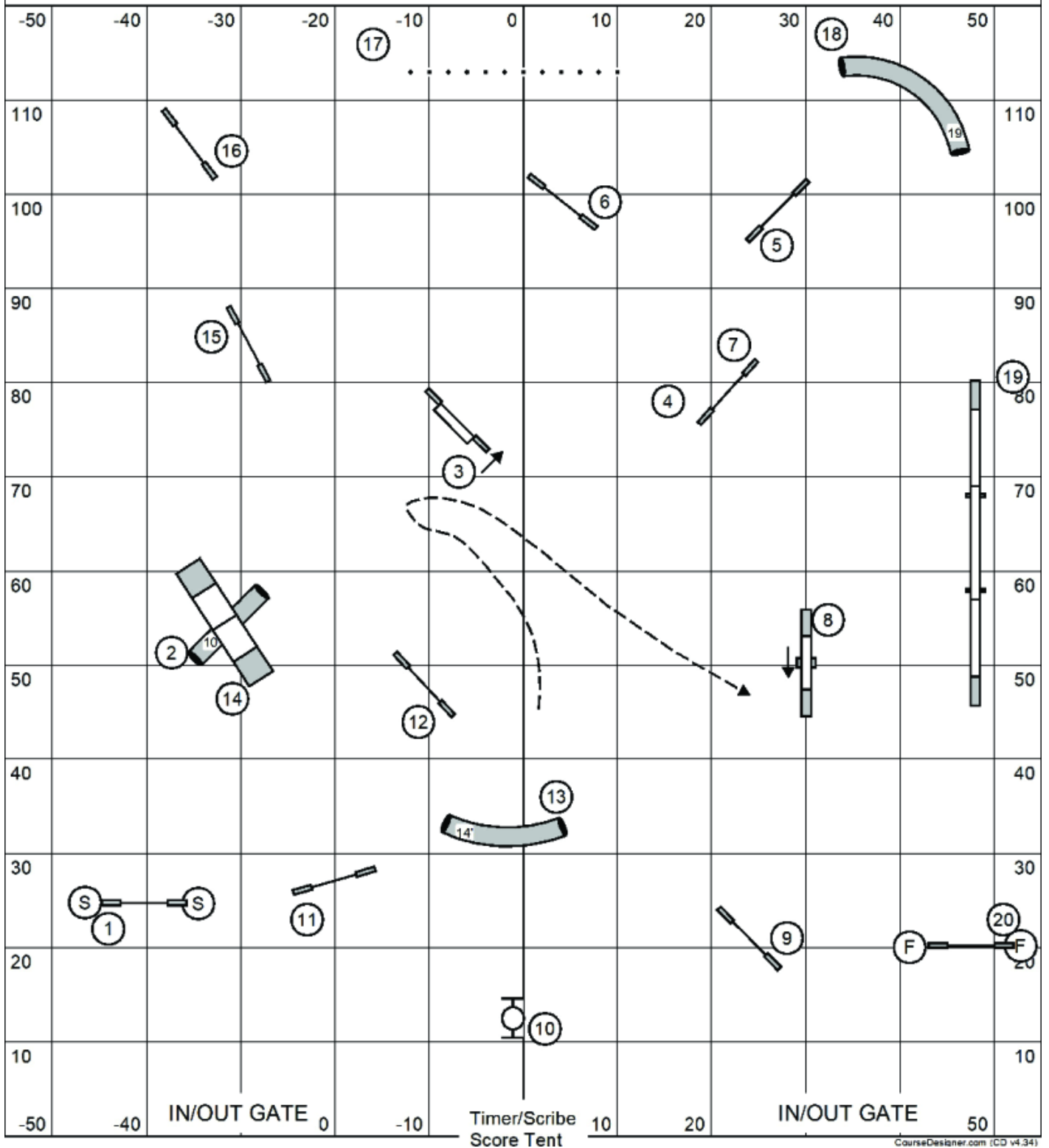

Data Driven Agility  
 USDA Trial  
 Judge Kelly Ely  
 May 10, 2026

# Biathlon MC Standard Agility

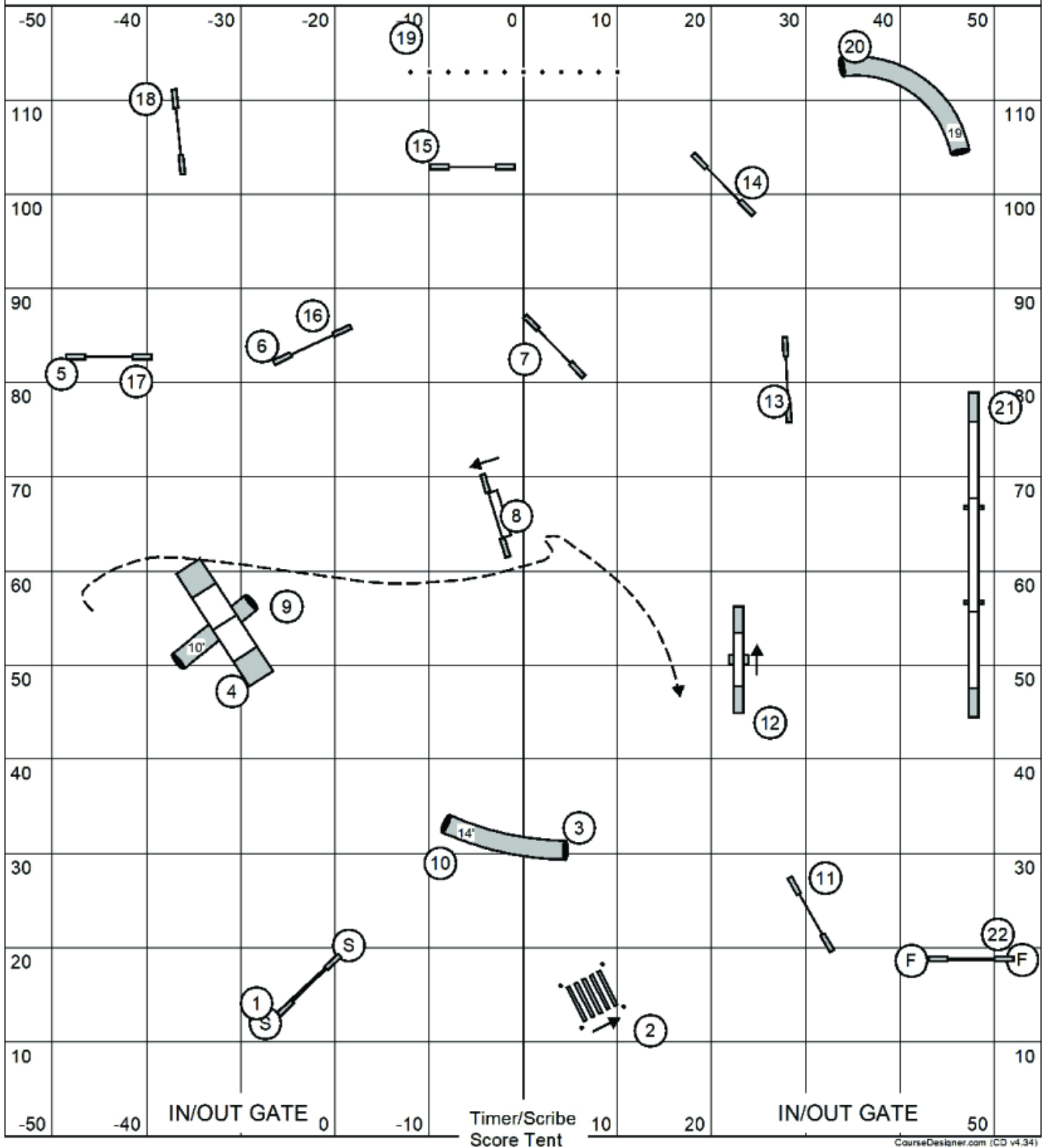

Data Driven Agility  
 USDAA Trial  
 Judge Kelly Ely  
 May 10, 2026

# Starters P1 Gamblers

1-3-5-7 points  
 teeter is 7 points  
 can only acquire  
 points 2x per obstacle

two gamble obstacles  
 taken in forward or  
 reverse negate the gamble

opening time 25sec  
 Joker times  
 Champ  
 24-20 = 14sec  
 16-12 = 15sec  
 8 = 16sec  
 Performance  
 20-16 = 15sec  
 12-8 = 16sec  
 4 = 17sec

no contacts done  
 back to back

No contact to contact

(do a thing take a thing)

jumps 1  
 tunnels tire 3  
 DW aframe weaves 5  
 teeter 7

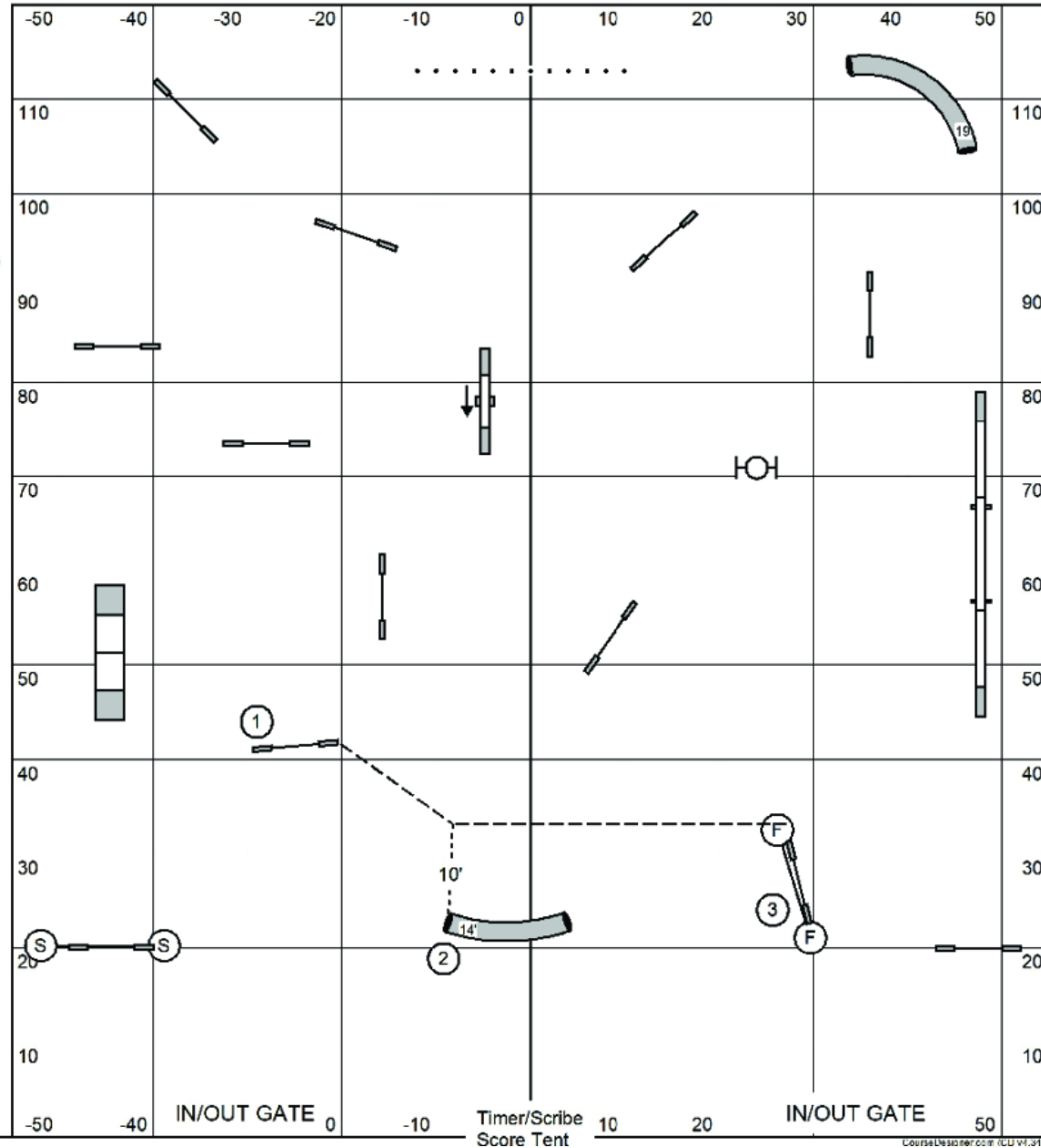

Data Driven Agility  
 USDAA Trial  
 Judge Kelly Ely  
 May 10, 2026

### Advanced P2 Gamblers

1-3-5-7 points  
 teeter is 7 points  
 can only acquire  
 points 2x per obstacle

two gamble obstacles  
 taken in forward or  
 reverse negate the gamble

opening time 25sec  
 Joker times  
 Champ  
 24-20 = 15sec  
 16-12 = 16sec  
 8 = 17sec  
 Performance  
 20-16 = 16sec  
 12-8 = 17sec  
 4 = 18sec

no contacts done  
 back to back

No contact to contact

(do a thing take a thing)

jumps 1  
 tunnels tire 3  
 DW aframe weaves 5  
 teeter 7

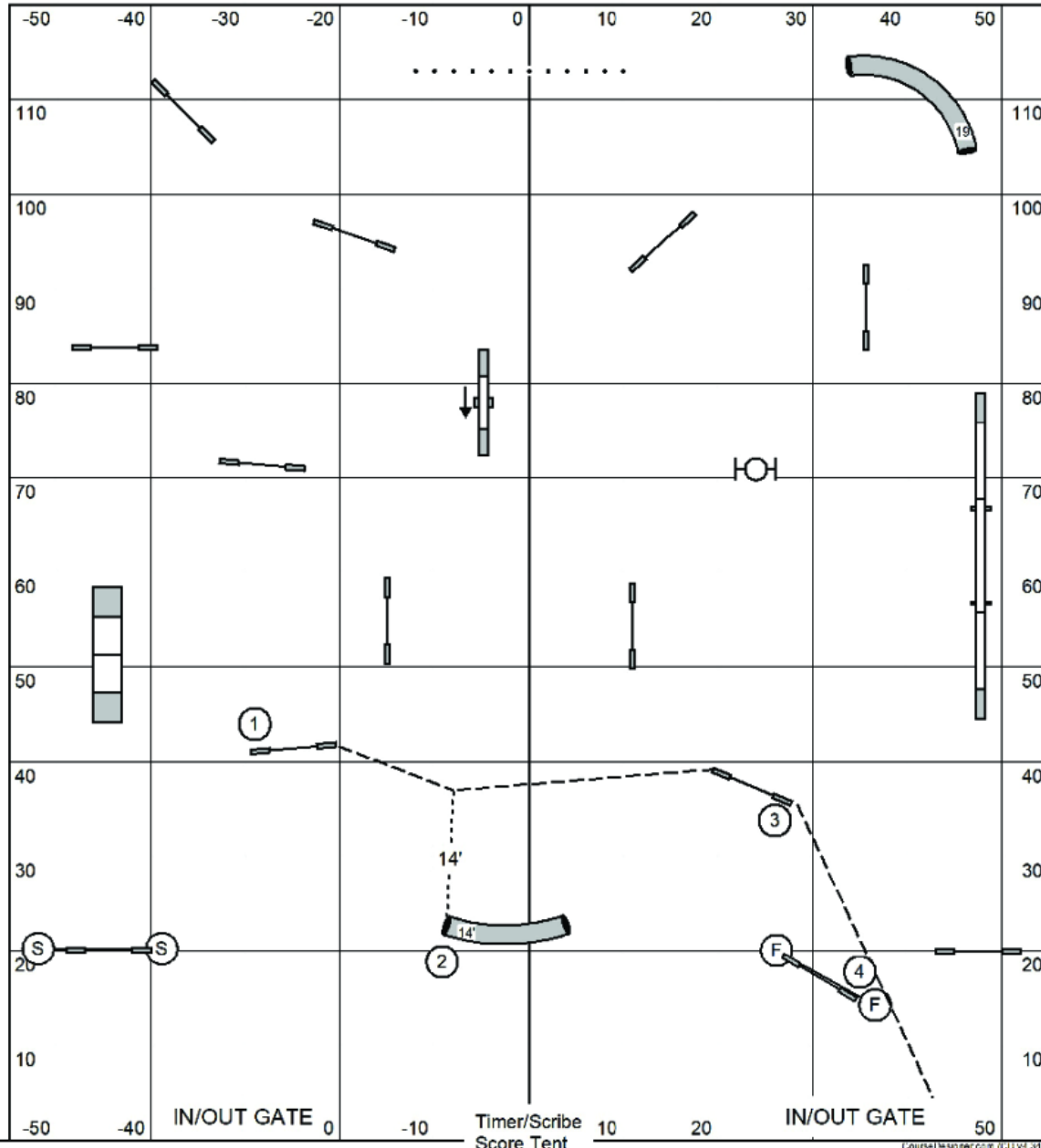

Data Driven Agility  
 USDAA Trial  
 Judge Kelly Ely  
 May 10, 2026

# Masters P3 Vet Gamblers

1-3-5-7 points  
 weaves are 7 points  
 can only acquire  
 points 2x per obstacle

two gamble obstacles  
 taken in forward or  
 reverse negate the gamble

opening time 25sec  
 Joker times  
 Champ  
 24-20 = 18sec  
 16-12 = 19sec  
 8 = 20sec  
 Performance  
 20-16 = 19sec  
 12-8 = 20sec  
 4 = 21sec  
 Vet +6

no contacts done  
 back to back

No contact to contact

(do a thing take a thing)

jumps 1  
 tunnels tire 3  
 DW aframe teeter 5  
 weaves 7

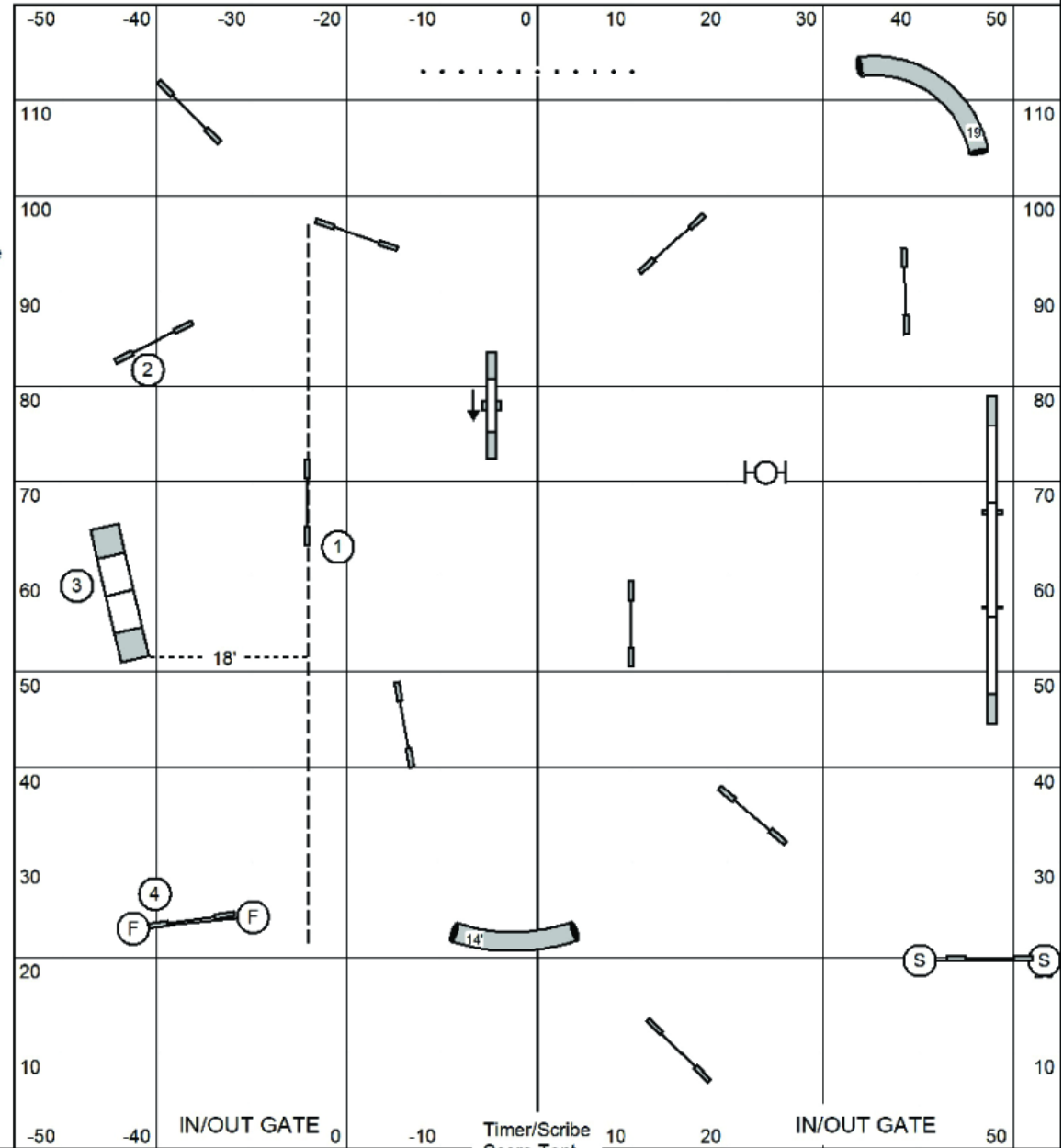

IN/OUT GATE 0

Timer/Scribe  
 Score Tent

IN/OUT GATE 50