

Pitstop 1
 April 11, 2026
Agility and Rally for Fun
 Gahanna, Ohio

Tunnel Bags
 10' Tunnel minimum 3
 15' Tunnel minimum 4
 20' Tunnel minimum 6

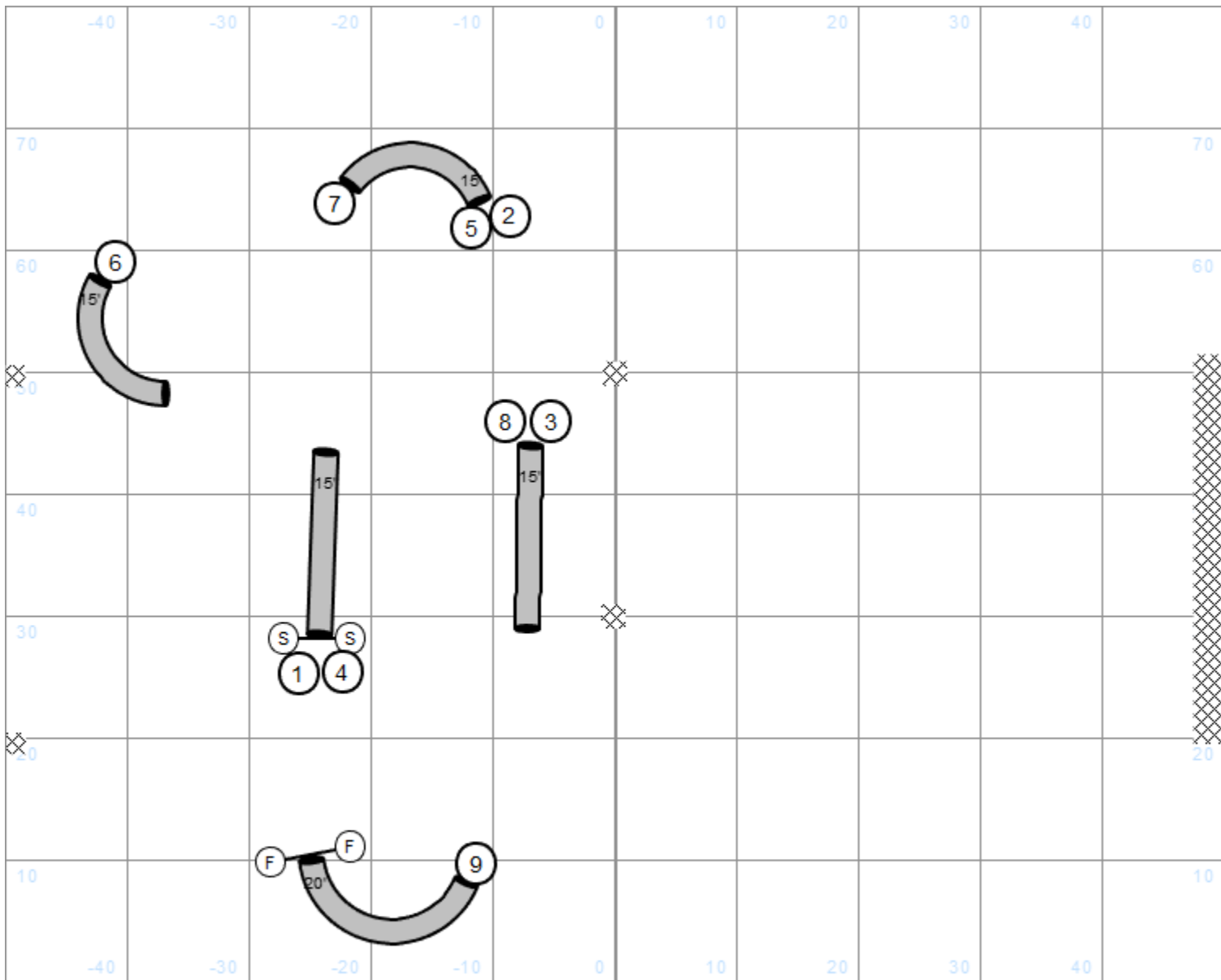

Pitstop 2
 April 11, 2026
Agility and Rally for Fun
 Gahanna, Ohio

Tunnel Bags
 10' Tunnel minimum 3
 15' Tunnel minimum 4
 20' Tunnel minimum 6

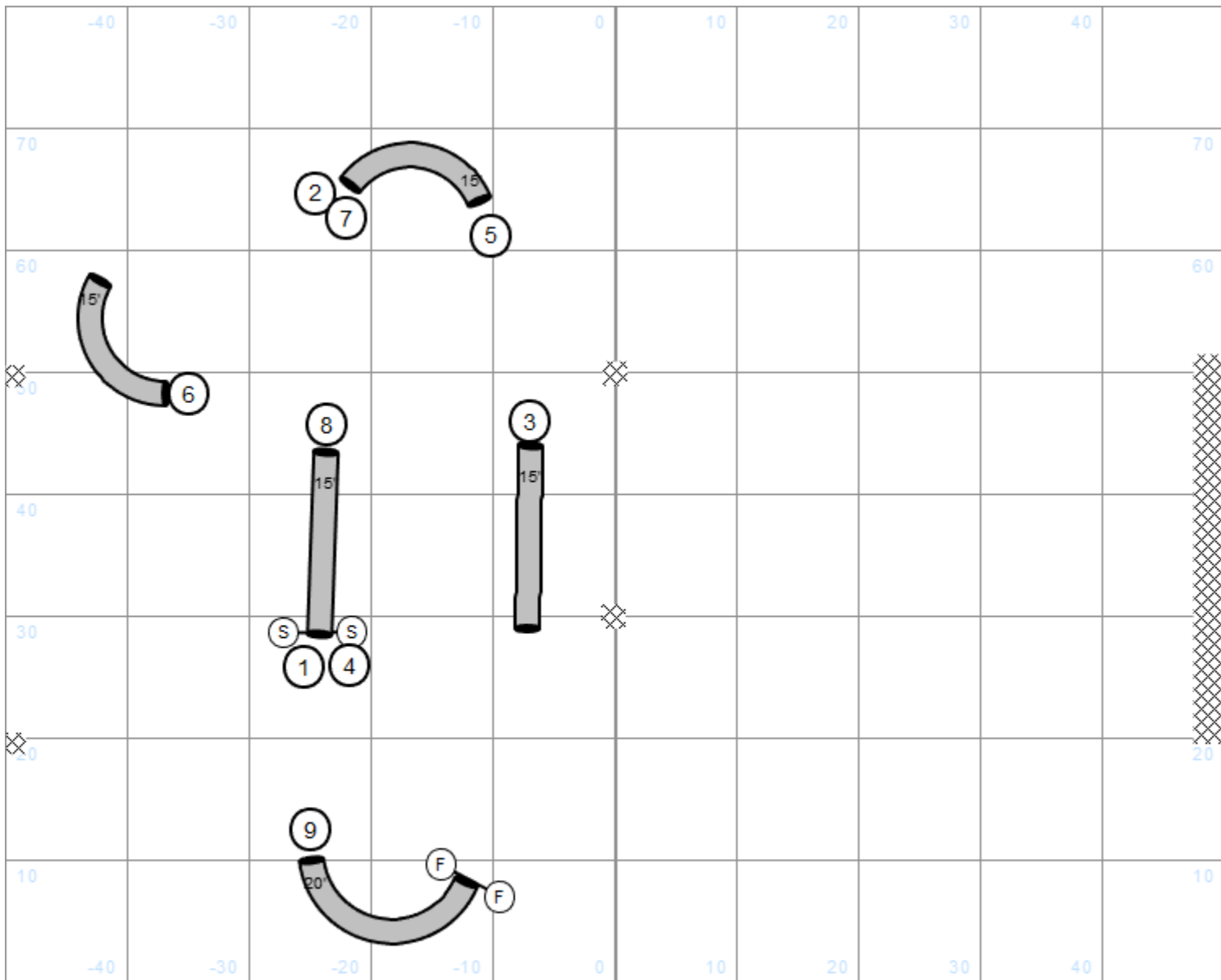

Pitstop 3
 April 11, 2026
Agility and Rally for Fun
 Gahanna, Ohio

Tunnel Bags
 10' Tunnel minimum 3
 15' Tunnel minimum 4
 20' Tunnel minimum 6

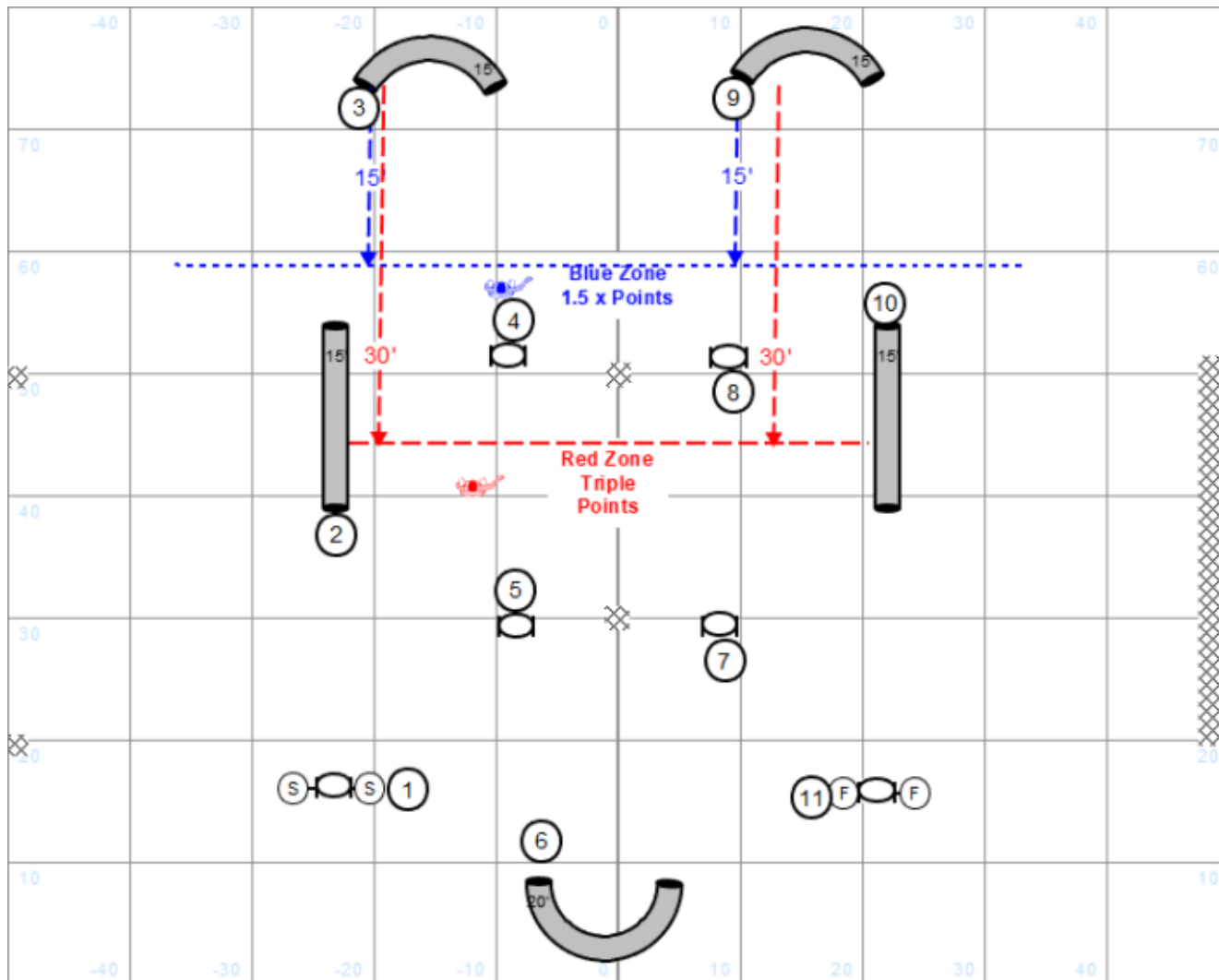

Slingshot 1

April 11, 2026

Agility and Rally for Fun

Gahanna, Ohio

Mid-Course Challenge

Handler must stay behind Blue or Red line while the dog completes the required obstacles to get a multiplier! In order to attain the 3X multiplier the handler must stay behind the Red Line while the dog performs obstacles 3-4 and 8-9 as marked on the map. In order to attain the 1.5X multiplier the handler must stay behind the Blue Line while the dog performs obstacles 3 and 9 as marked on the map. In addition, all obstacles on the course must be performed without any required corrections to qualify with a multiplier. Obstacle corrections allow for a score but in that case the multiplier is voided.

Handlers may choose to run the entire path with their dog for no multiplier.

Tunnel Bags

- 10' Tunnel minimum 3
- 15' Tunnel minimum 4
- 20' Tunnel minimum 6

Slingshot 2
 April 11, 2026
Agility and Rally for Fun
 Gahanna, Ohio

Lateral Lead Out Challenge

Handler must be across the Blue or Red line before the dog starts the course. In order to attain the 3X multiplier the handler must stay behind the Red Line while the dog performs obstacles 1-6. In order to attain the 1.5X multiplier the handler must stay behind the Blue Line while the dog performs obstacles 1-3. In addition,

all obstacles on the course must be performed without any required corrections to qualify with a multiplier. Obstacle corrections allow for a score but in that case the multiplier is voided.

Handlers may choose to run the entire path with their dog for no multiplier.

Tunnel Bags

- 10' Tunnel minimum 3
- 15' Tunnel minimum 4
- 20' Tunnel minimum 6

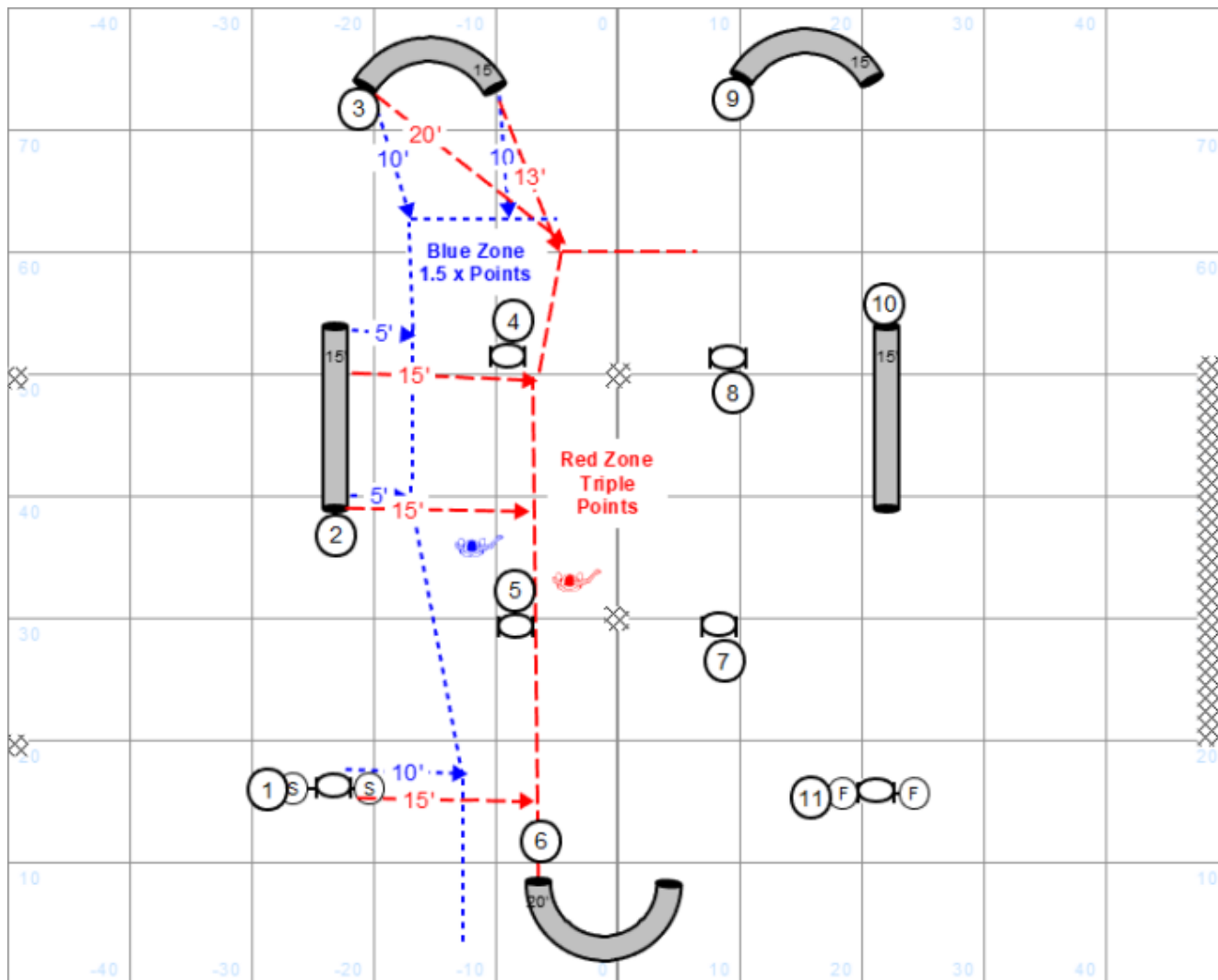

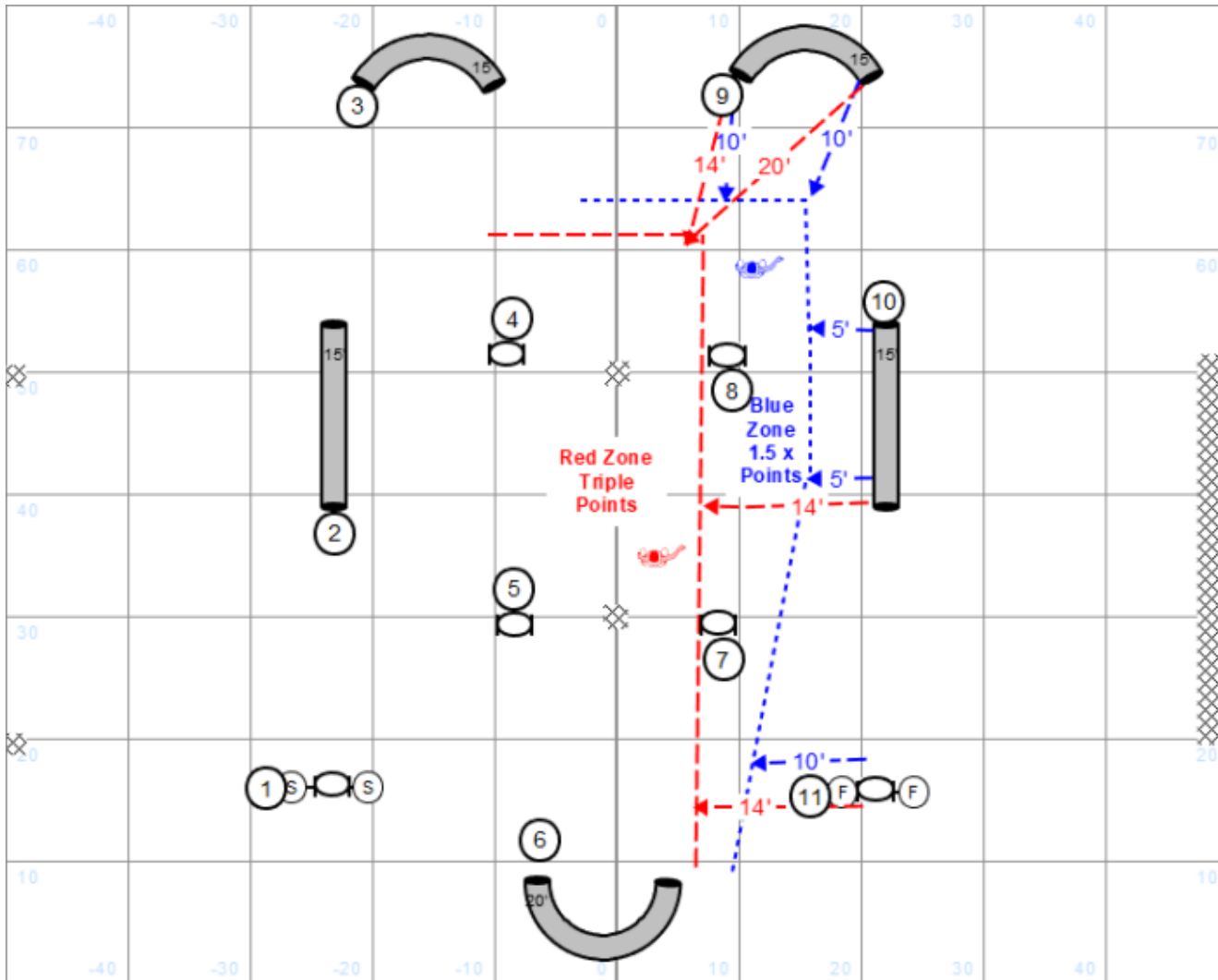

Slingshot 3
 April 11, 2026
Agility and Rally for Fun
 Gahanna, Ohio

Finish Challenge

Handler must be across the Blue or Red line before the dog starts the course. In order to attain the 3X multiplier the handler must stay behind the Red Line while the dog performs obstacles 7-11 In order to attain the 1.5X multiplier the handler must stay behind the Blue Line while the dog performs obstacles 9-11 In addition,

all obstacles on the course must be performed without any required corrections to qualify with a multiplier. Obstacle corrections allow for a score but in that case the multiplier is voided.

Handlers may choose to run the entire path with their dog for no multiplier.

Tunnel Bags

- 10' Tunnel minimum 3
- 15' Tunnel minimum 4
- 20' Tunnel minimum 6

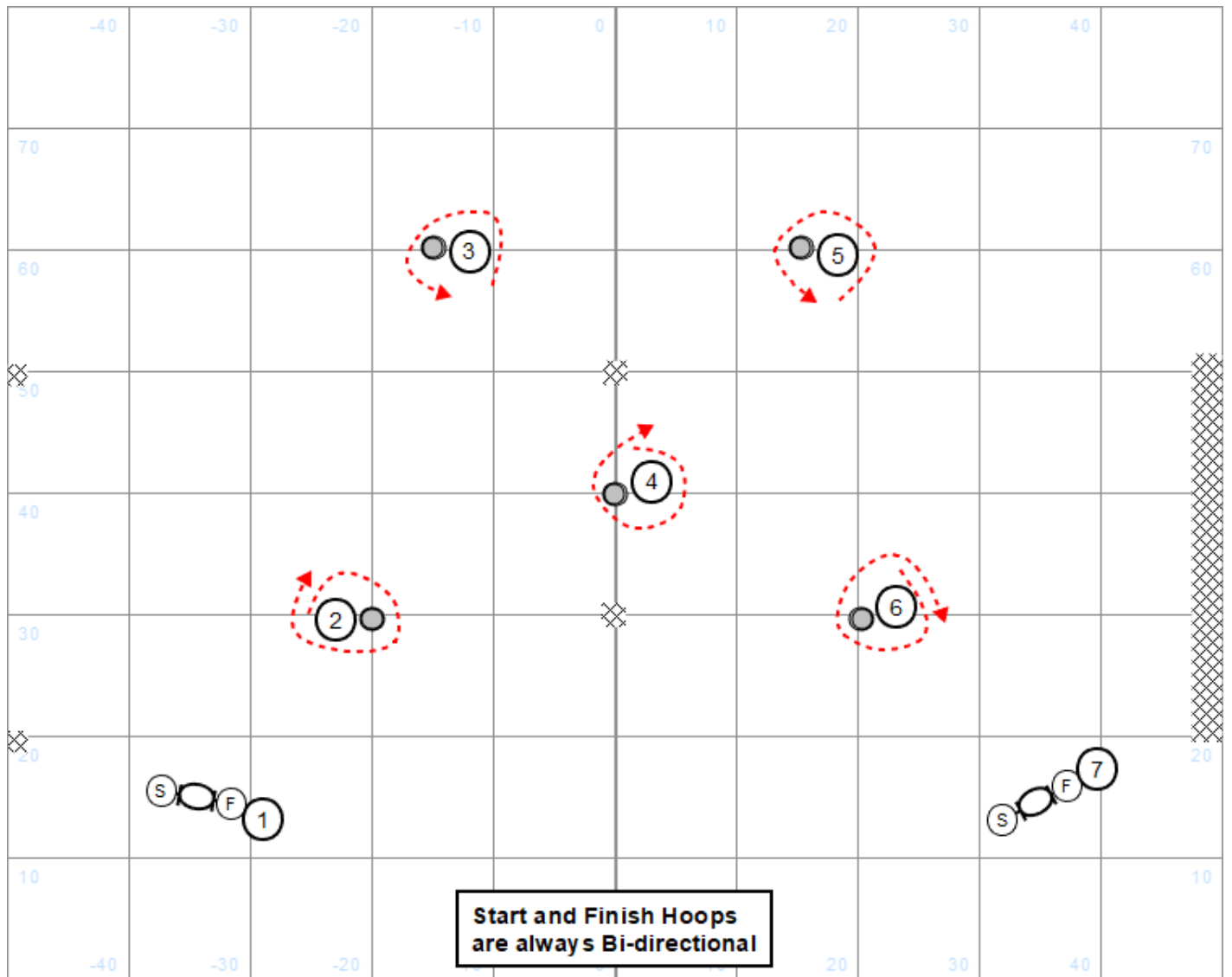

Pole Position Solo Rd 1

April 11, 2026

Agility and Rally for Fun

Gahanna, Ohio

Pole Position Solo Course Set D Course 1

General Reminders: Start and finish hoops are Bi-Directional. The number is on the side of the barrel the dog should approach from. Fix any errors (dog going the wrong way around a barrel or taking an incorrect barrel).

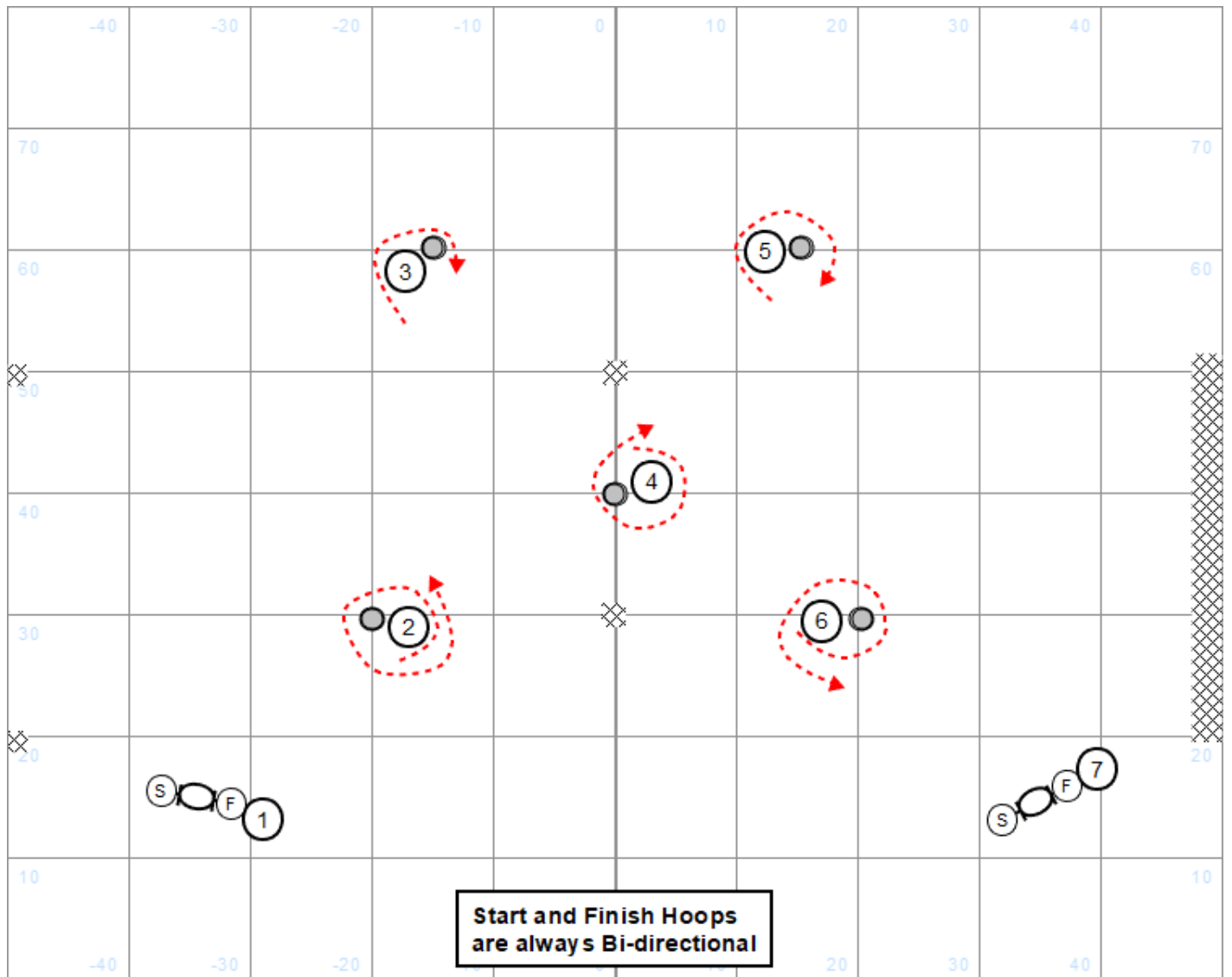

Pole Position Solo Rd 2

April 11, 2026

Agility and Rally for Fun

Gahanna, Ohio

Pole Position Solo Course Set D Course 1

General Reminders: Start and finish hoops are Bi-Directional. The number is on the side of the barrel the dog should approach from. Fix any errors (dog going the wrong way around a barrel or taking an incorrect barrel).