

Masters / P3 / Vets Standard
 Riverside Canine Center -- New England Regional -- July 8, 2021 -- Mike Murphy

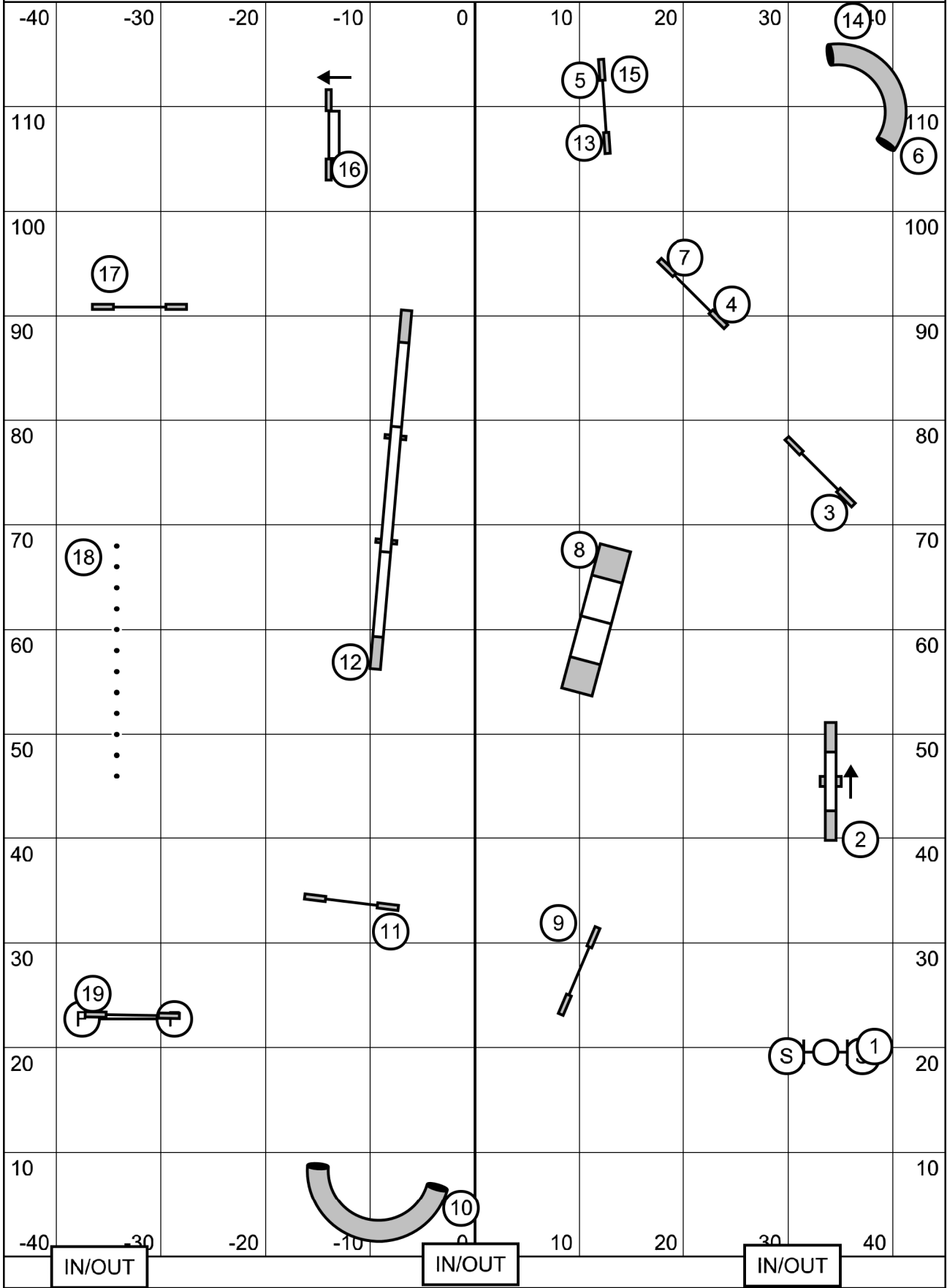

July, 8th 2022

Masters/P/III/Vet Gamblers

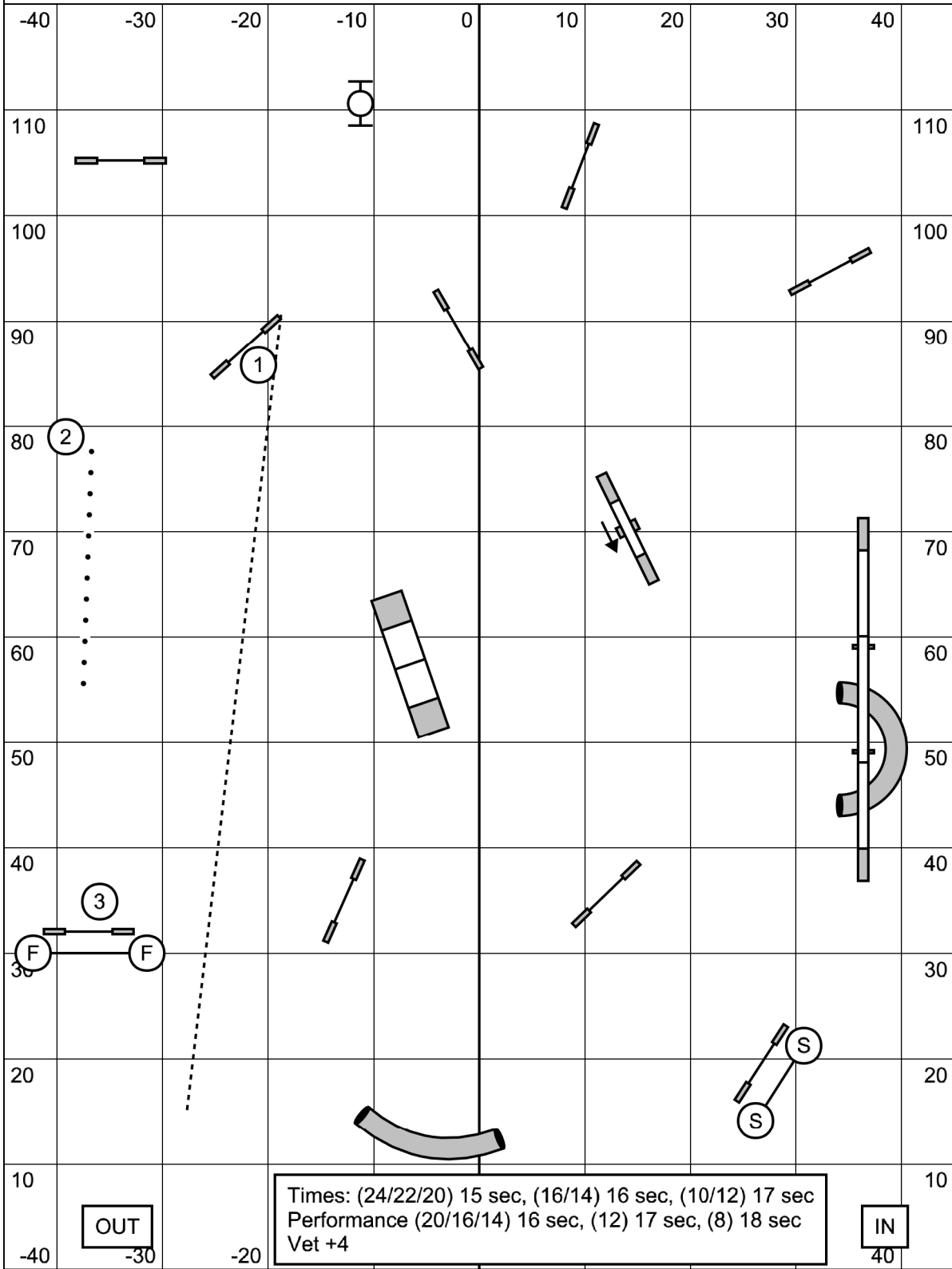

Riverside Canine Center
New England Regional
USDAA

Stephen Routh

1-3-5-7 System 18 points in the opening
Dog Walk 7, other contacts and weaves 5, tunnels/tire 3, jumps 1
No consecutive contacts, back to back OK
25 second opening Start Jump Bi-Directional

Team Gamblers
 Riverside Canine Center -- New England Regional -- July 8, 2021 -- Mike Murphy

Gamble: Must start with #1 and go to #2 tunnel. After that #1 & #2 can be repeated as many times as want, in any order/direction, but must cross finish line before time or lose gamble points. Jump 1pt, Tunnels 3pt each. If do all jumps and tunnel(s) behind line get 7 pts one time. Can seq gamble in opening. No refusals in closing. Finish is bi-directional. If fault #1 &/or #3 in opening, gamble still can be done, just 0 pts for faulted.

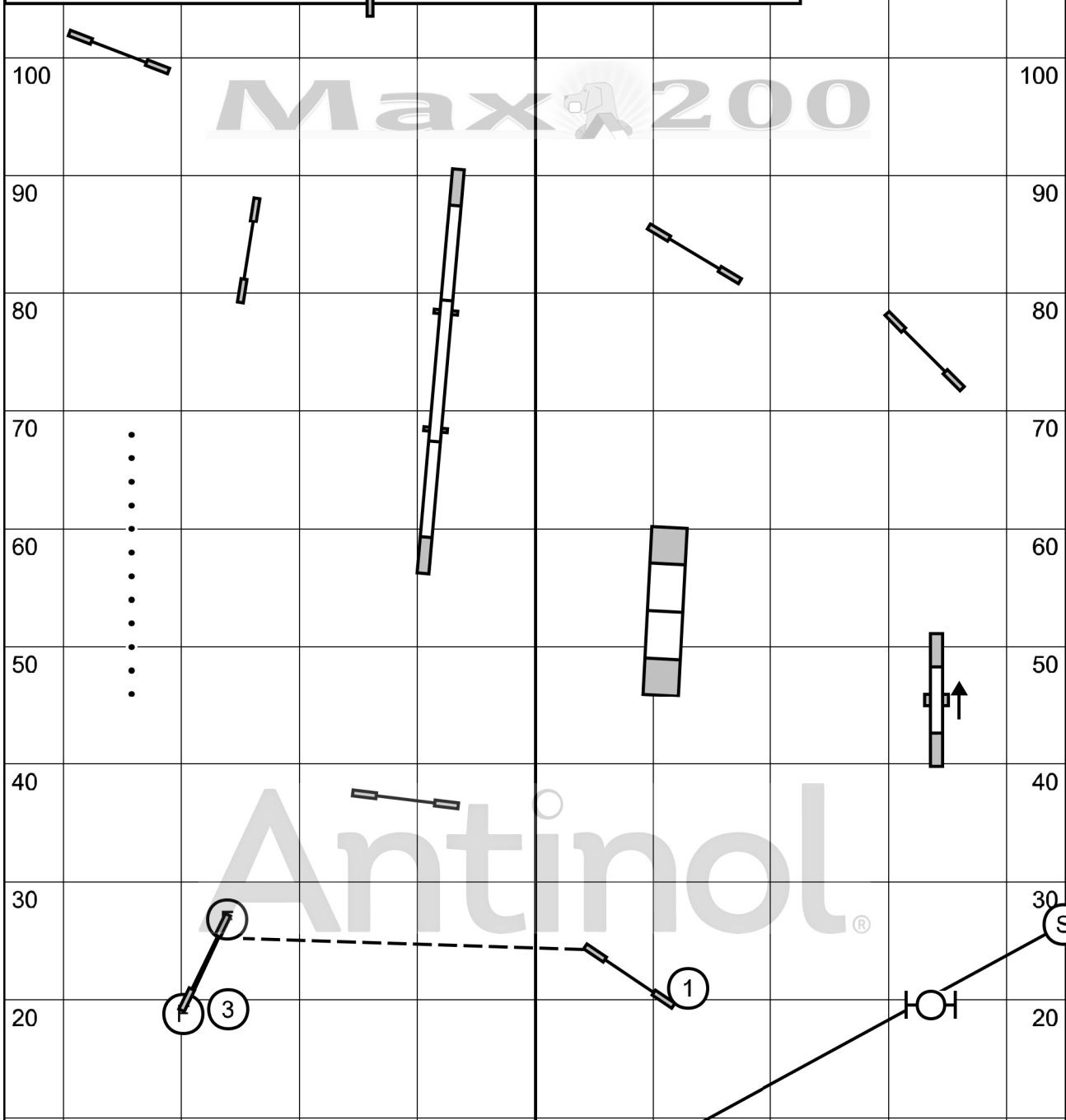
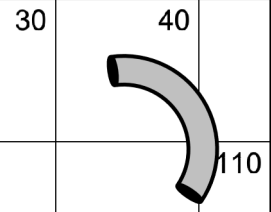

Team Weighting
 Factor = 1.25

Gamble times: 20/22/24 & P14/16/20: 16 sec
 14/16 & P12: 17 10/12 & P8: 18 sec

Back to Back: YES
 Consecutive Contacts: NO

1-3-5-7 System, Teeter 7 points Opening:
 20/22/24 & P14/16/20: 25 sec 14/16 & P12: 28 sec 10/12 & P8: 30 sec

July, 8th 2022

Team/PVP Standard

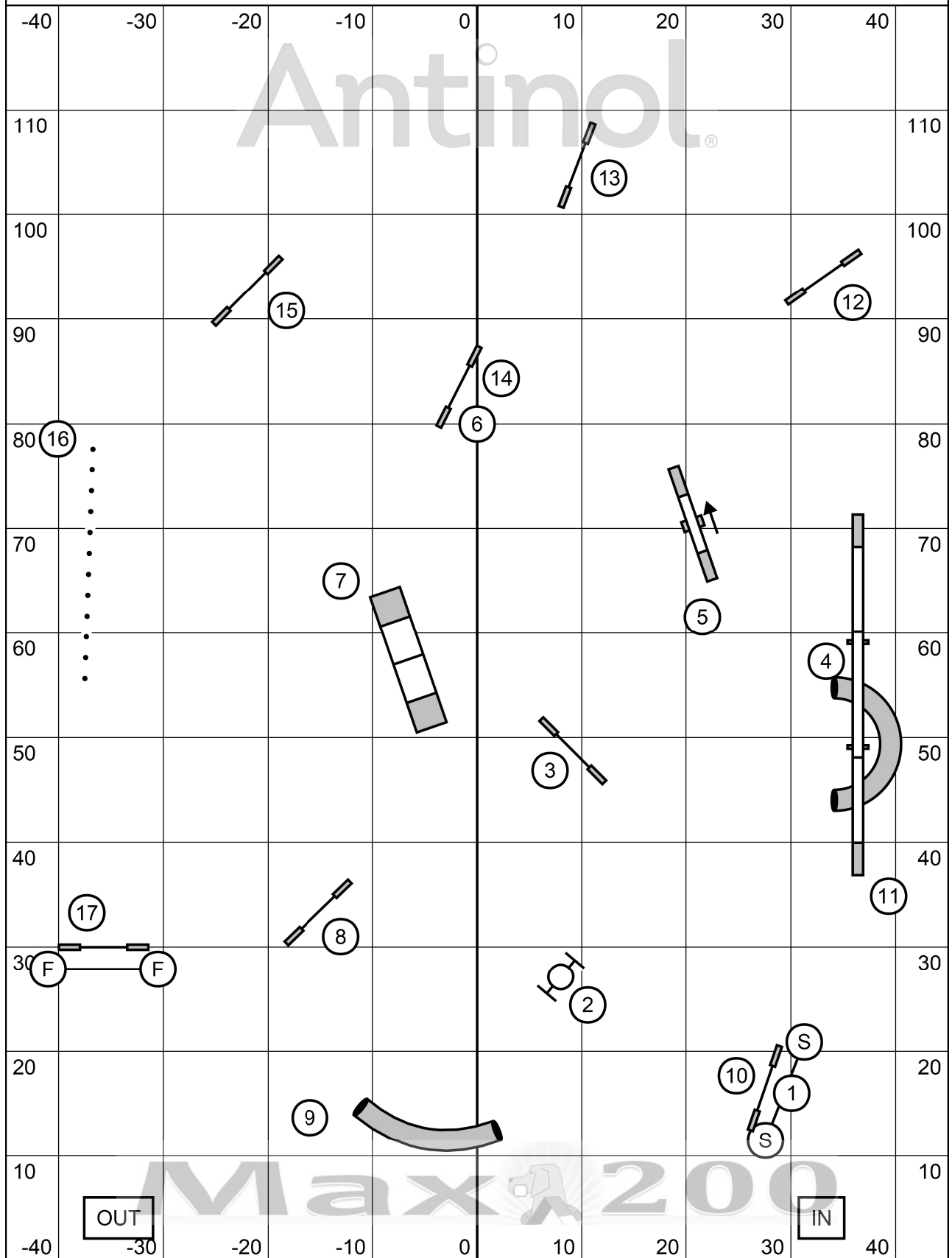

Riverside Canine Center
New England Regional
USDAA

3 dog team sponsored by Max 200
2 dog team sponsored by Antinol

Stephen Routh

Biathlon Standard
 Riverside Canine Center -- New England Regional -- July 8, 2021 -- Mike Murphy

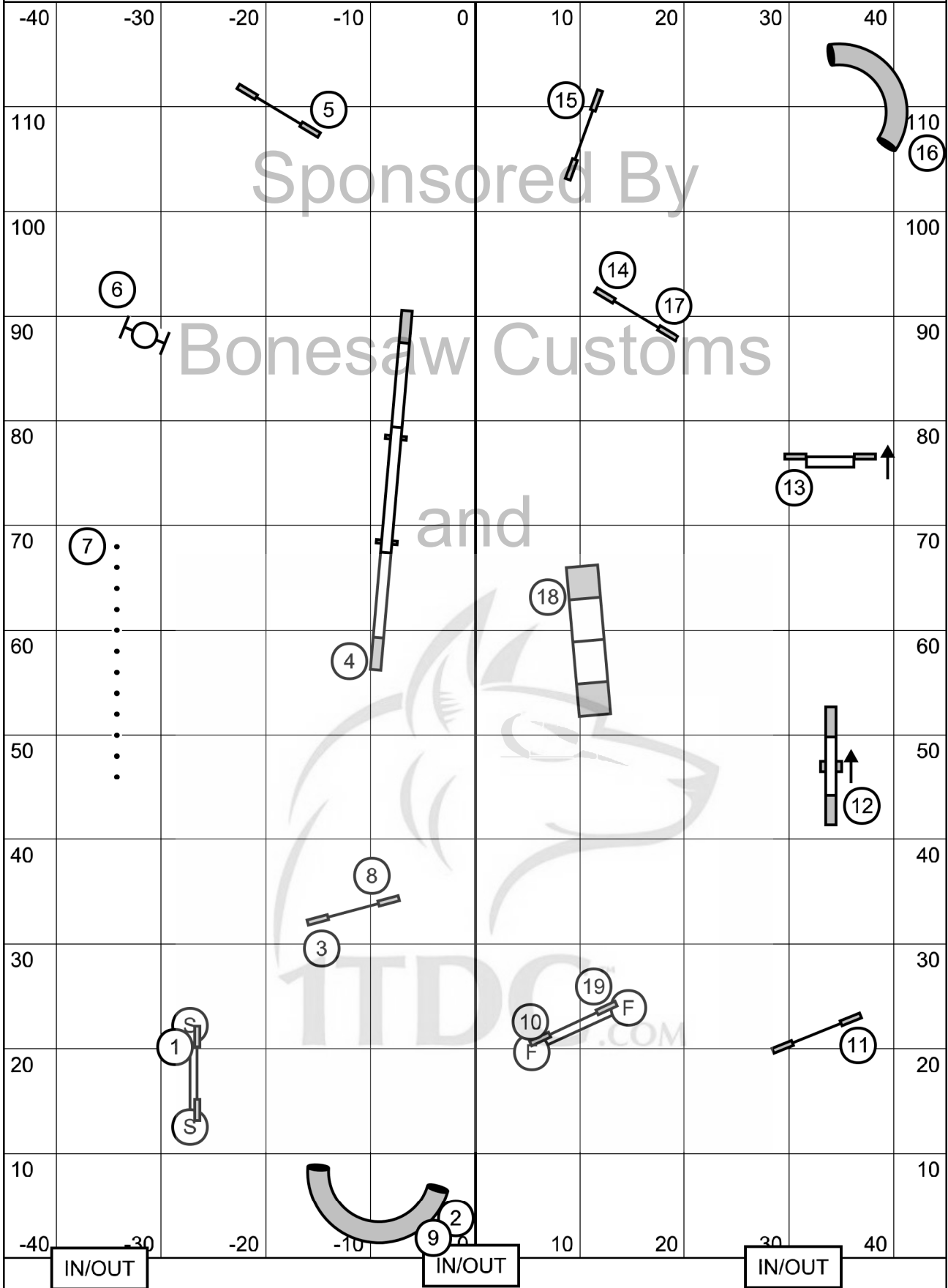

July, 8th 2022

Advanced/PI Standard

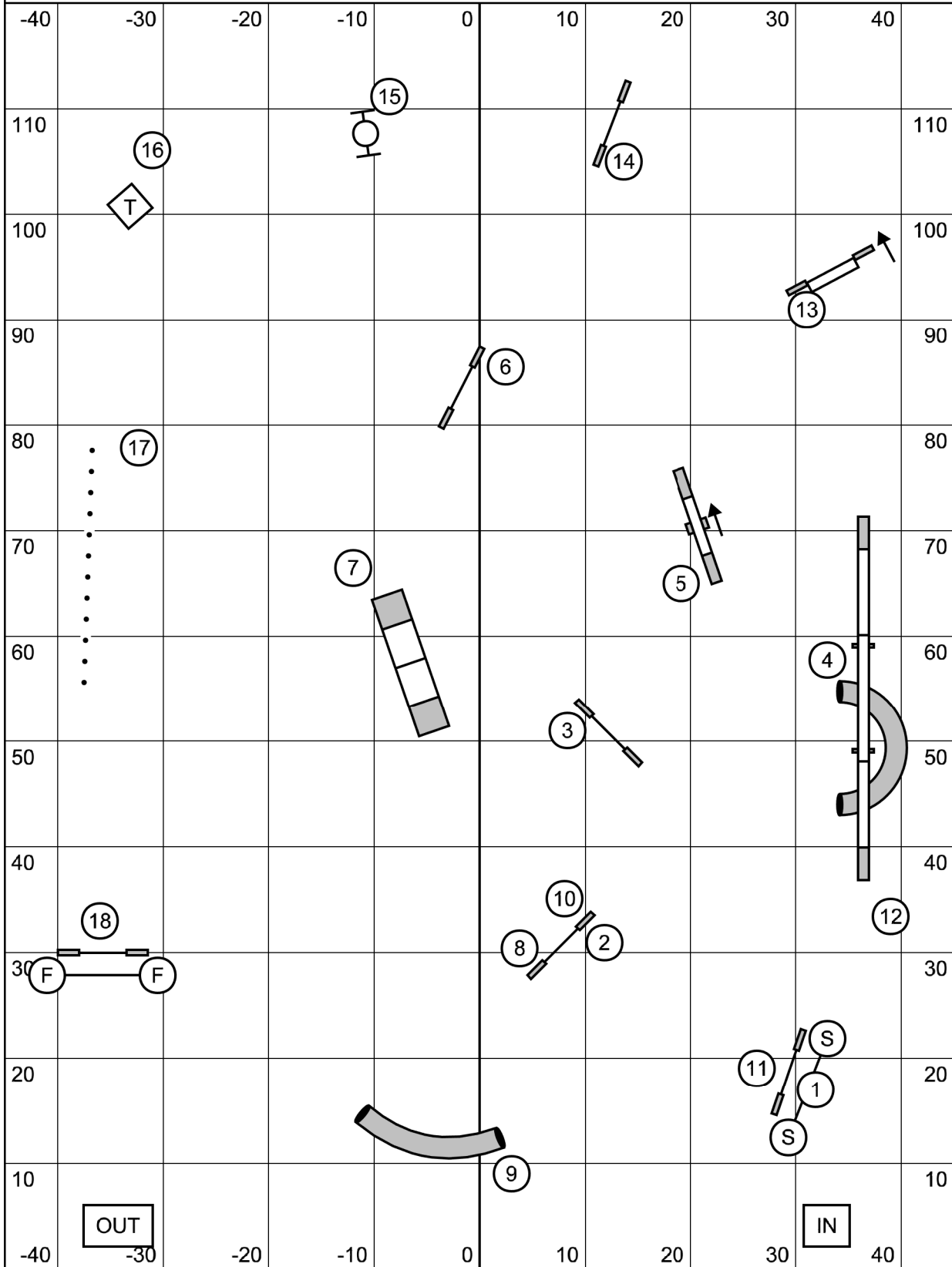

Riverside Canine Center
New England Regional
USDAA

Stephen Routh

Advanced / P2 Jumpers
 Riverside Canine Center -- New England Regional -- July 8, 2021 -- Mike Murphy

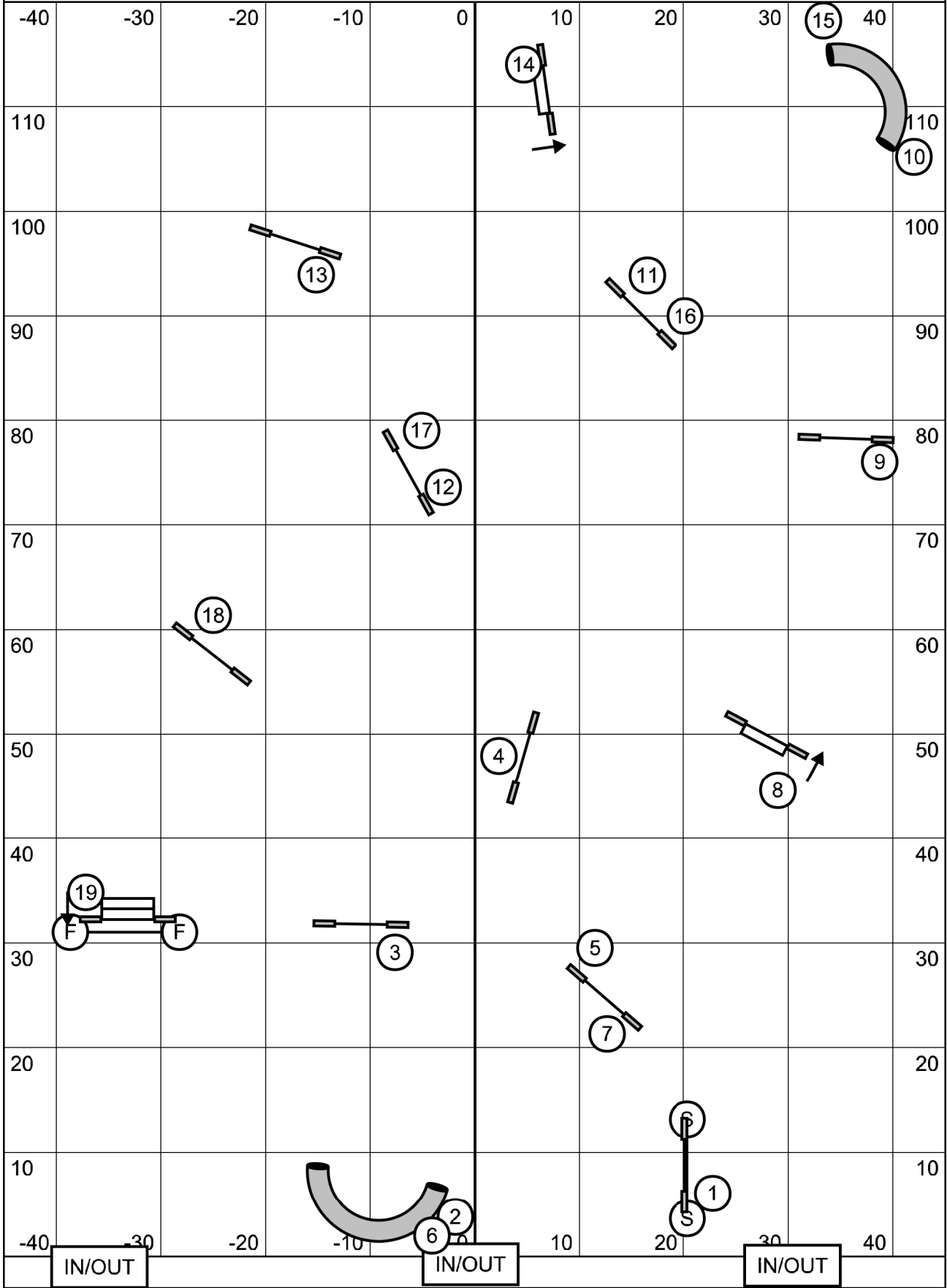

July, 8th 2022

Starters/PI Standard

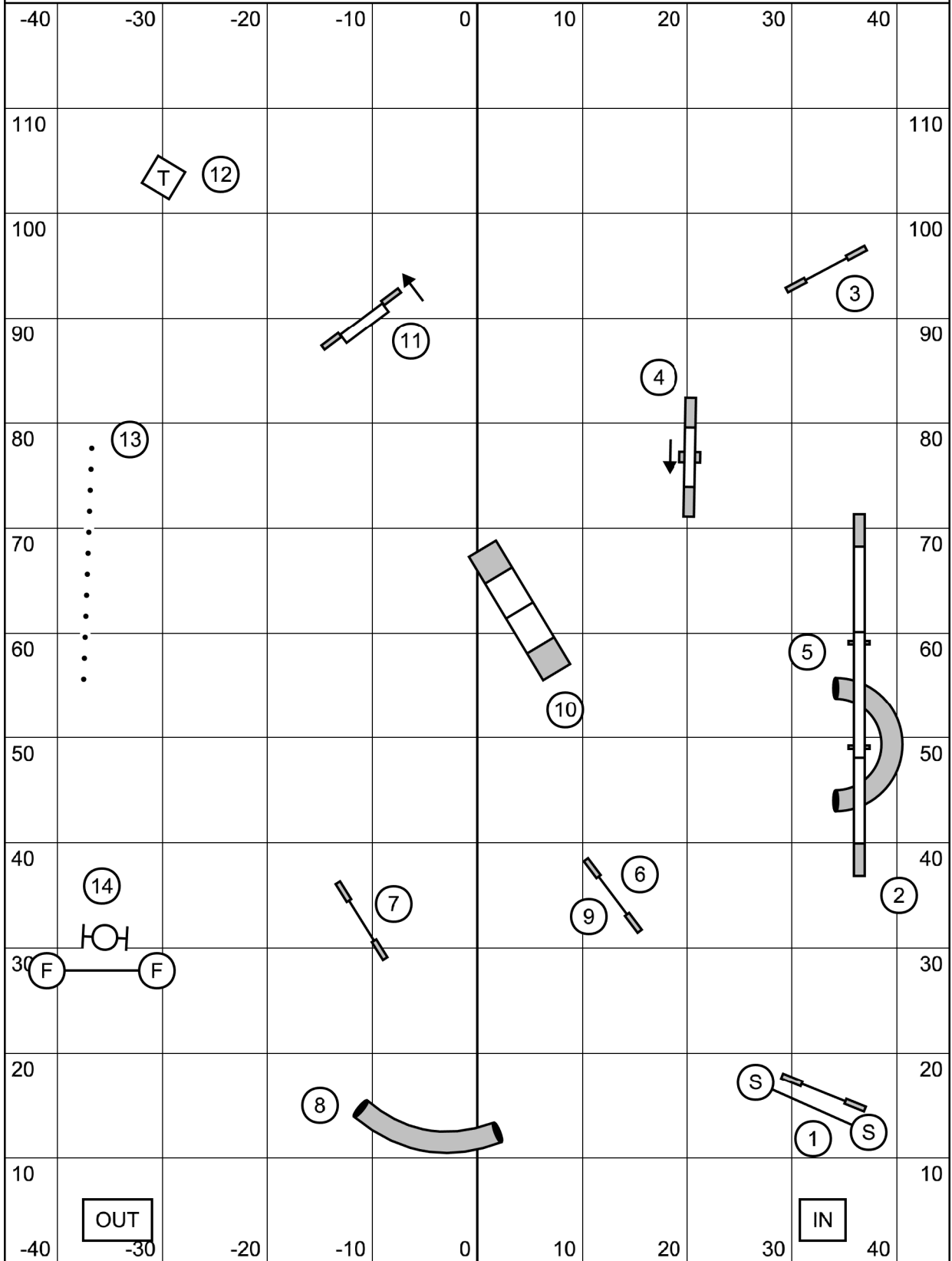

Riverside Canine Center
New England Regional
USDAA

Stephen Routh

July, 8th 2022

MC Biathlon Jumpers

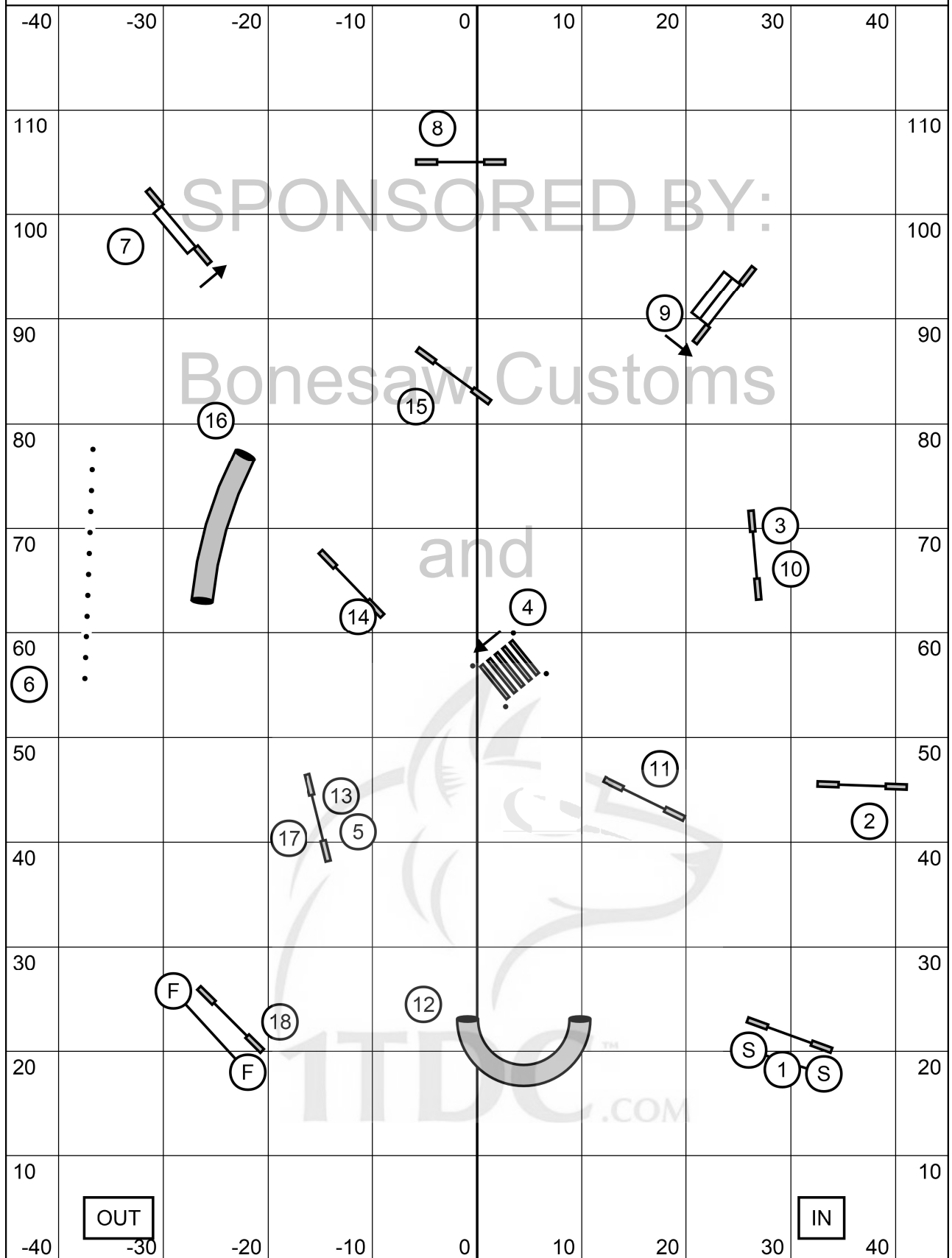

Riverside Canine Center
New England Regional
USDA

Stephen Routh

Sponsored by: Bonesaw Customs and 1-tdc

Starters / P1 Jumpers
 Riverside Canine Center -- New England Regional -- July 8, 2021 -- Mike Murphy

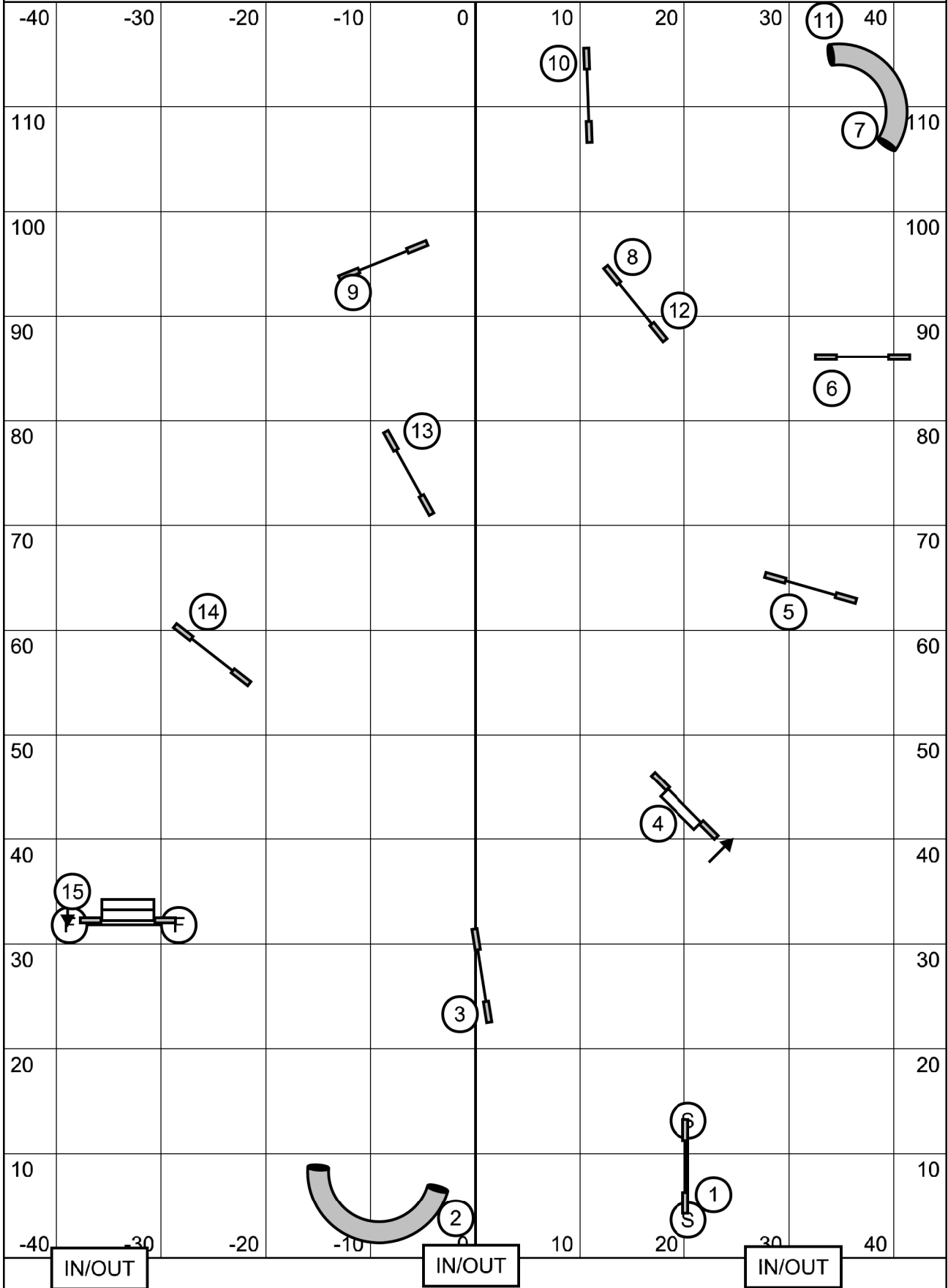

Advanced / P2 Snooker
 Riverside Canine Center -- New England Regional -- July 8, 2021 -- Mike Murphy

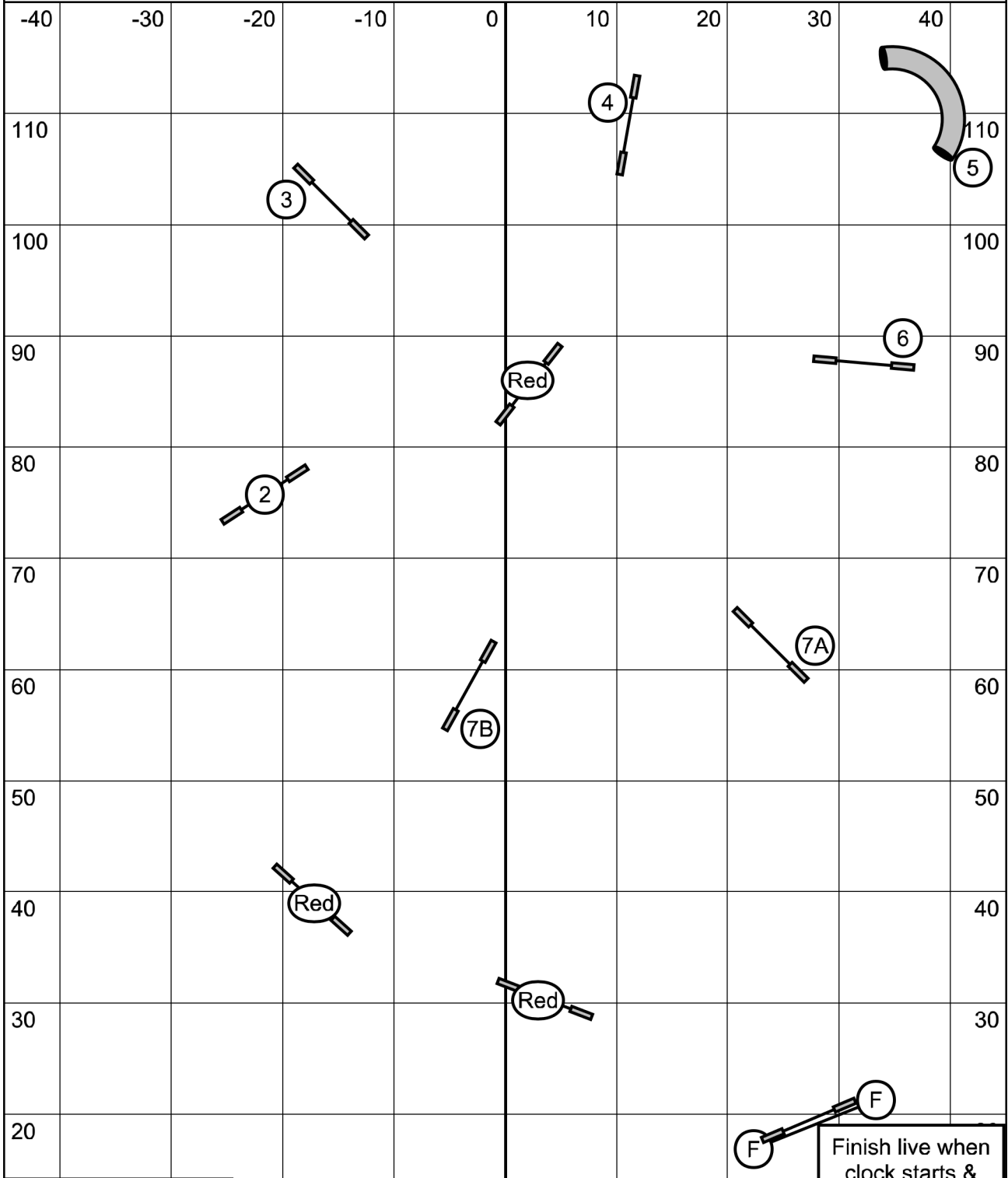

Start is bi-directional and can be reused

Finish live when clock starts & bi-directional

All obstacles bi-directional in the opening.
 #2 and #5 bi-directional in closing as well

In opening, repeated obstacles within a combo must be corrected for zero points

Champ: 10: 50 sec, 14/16: 48 sec, 20/22/24: 46 sec
 Perf: 8: 52 sec, 12: 50 sec, 14/16/20: 48 sec

Starters / P1 Snooker
 Riverside Canine Center -- New England Regional -- July 8, 2021 -- Mike Murphy

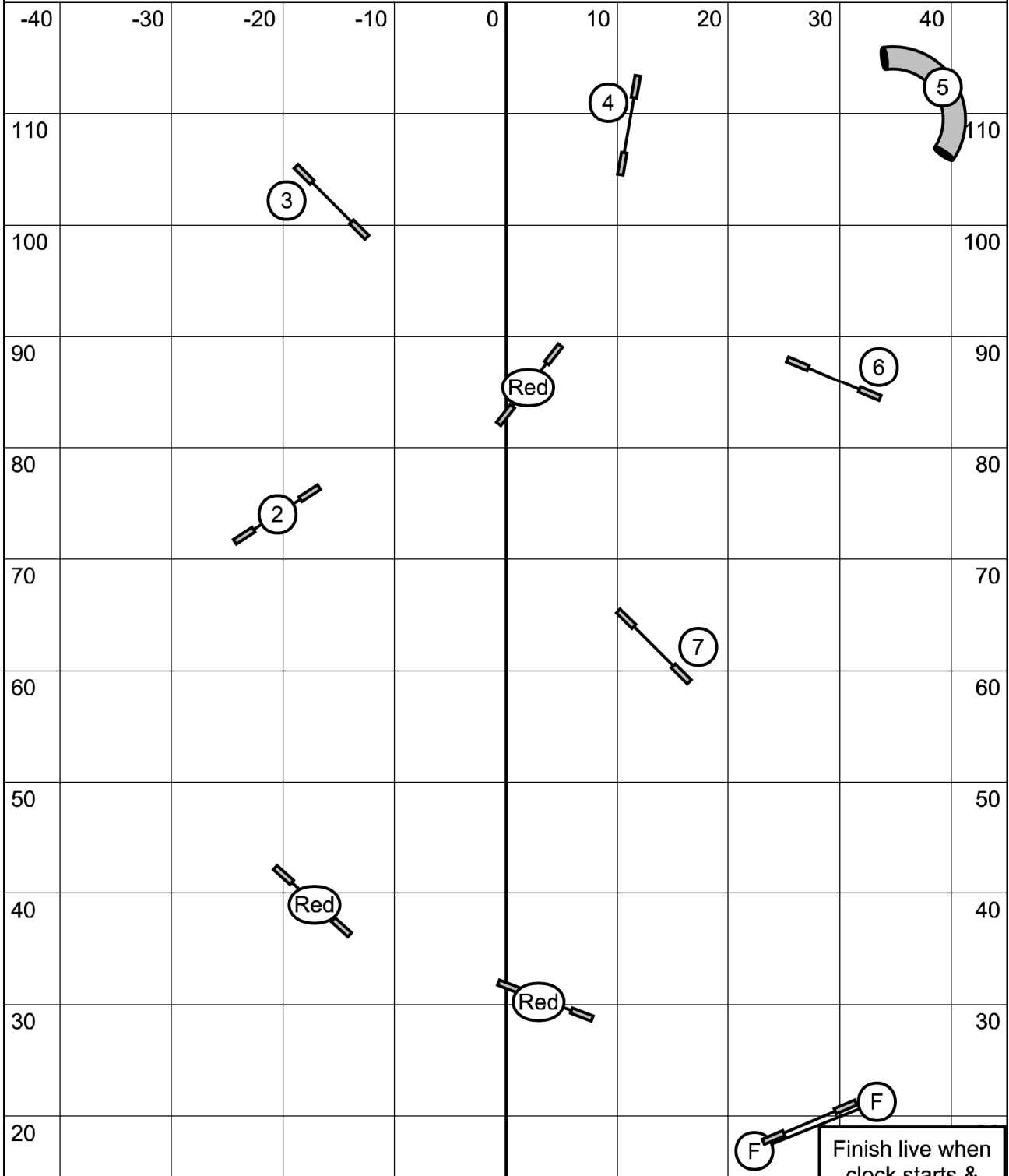

Start is bi-directional and can be reused

Finish live when clock starts & bi-directional

All obstacles bi-directional in the opening.
 #2 and #5 bi-directional in closing as well

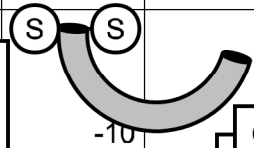

In opening, repeated obstacles within a combo must be corrected for zero points

Champ: 10: 54 sec, 14/16: 52 sec, 20/22/24: 50 sec
 Perf: 8: 56 sec, 12: 54 sec, 14/16/20: 52 sec